

FM 6-02.43

SIGNAL SOLDIER'S GUIDE

March 2009

**DISTRIBUTION RESTRICTION: Approved for public release;
distribution is unlimited.**

**HEADQUARTERS,
DEPARTMENT OF THE ARMY**

This publication is available at
Army Knowledge Online (www.us.army.mil) and
General Dennis J. Reimer Training and Doctrine
Digital Library at (www.train.army.mil).

SIGNAL SOLDIER'S GUIDE

Contents

	Page
PREFACE	vii
INTRODUCTION	ix
Chapter 1 SIGNAL SOLDIER'S ROLES AND RESPONSIBILITIES	1-1
Signal Soldier Responsibilities to the Commander	1-1
Battalion S-6 Officer	1-3
Brigade S-6 Officer	1-7

DISTRIBUTION RESTRICTION: Approved for public release; distribution is unlimited.

Contents

Signal Company Commanders 1-17

Division Command and Control 1-18

G-6 Responsibilities at the Division

Command Posts 1-20

Division G-6 Officer Roles and Responsibilities 1-21

The Corps 1-36

Corps Command Posts 1-37

G-6 Responsibilities at the Corps

Command Posts 1-38

Corps G-6 Officer 1-41

Network Systems Maintenance 1-46

Army Force Generation Model 1-47

Chapter 2 SIGNAL PLANNING PROCESS 2-1

Signal Leader's Role in the Military

Decision Making Process 2-1

G-6/S-6 Troop Leading Procedures and the Military Decision Making Process 2-18

Additional Signal Support Equipment

Checks During Operations 2-25

Chapter 3 THE NETWORK 3-1

Global Information Grid 3-1

LandWarNet 3-3

Network Command and Control 3-5

Network Operations 3-6

Information Protection 3-6

Network Service Center 3-8

G-6/S-6 Network Operations 3-9

Current and Future Networks 3-11

Chapter 4	THEATER OPERATIONS	4-1
	Leveraging Theater Operation Assets	4-1
	Providing “Other” Service Support.....	4-2
	Section I – Major Commands	4-4
	NETCOM/9 th SC(A).....	4-4
	Section II – Strategic and Fixed Station Elements	4-10
	Strategic Signal Brigades	4-11
	Section III – Signal Operations	4-19
	Organizations for the Modular Force	4-19
Chapter 5	TRANSPORT SYSTEMS	5-1
	WIN-T Increment 1	5-1
	Mobile Subscriber Equipment.....	5-11
	Tri-Service Tactical	5-14
Chapter 6	FEDERATION OF NETWORKS	6-1
	Introduction	6-1
	Blue Force Tracking.....	6-2
	Army Battle Command System.....	6-3
	Combat Service Support Very Small Aperture Terminal	6-3
	Public Affairs Office Digital Video and Imagery Distribution System.....	6-8
	Global Broadcast System	6-9
	TeleEngineering Operations Center	6-15
	Standardized Integrated Command Post System.	6-16

Contents

**Appendix A ELECTROMAGNETIC SPECTRUM
MANAGEMENT OPERATIONS A-1**

Appendix B ARMY BATTLE COMMAND SYSTEM B-1

**Appendix C SIGNAL MILITARY OCCUPATIONAL
SPECIALTIES C-1**

Appendix D SIGNAL ANNEX TO AN OPORD D-1

Appendix E MAINTENANCE E-1

GLOSSARY Glossary-1

REFERENCES References-1

INDEX Index - 1

Figures

Figure 1-1. BCT S-6 staff organization 1-8

Figure 1-2. BCT signal company organizational structure..... 1-13

Figure 1-3. Modular support brigades signal company
organizational structure 1-16

Figure 1-4. Division G-6 section organization..... 1-25

Figure 1-5. Division G-6 section organizations..... 1-26

Figure 1-6. Division signal company organization 1-34

Figure 1-7. Corps G6 section organization 1-39

Figure 1-8. Corps G6 section organization 1-40

Figure 2-1. Example of a signal wargaming matrix..... 2-12

Figure 2-2. COA evaluation criteria 2-13

Figure 2-3. Sample COA comparison briefing slide 2-14

Figure 2-4. Sample LOS study..... 2-24

Figure 4-1. NETCOM/9th SC(A) Organization 4-5

Figure 4-2. Strategic design.....4-15

Figure 4-3. SC(T) subordinate elements4-24

Figure 4-4. 7TH SC(T) organization4-27

Figure 4-5. Theater tactical signal brigade 4-30

Figure 4-6. The ESB structure4-37

Figure 4-7. Theater TIN company.....4-43

Figure 4-8. Theater COMCAM company4-47

Figure 4-9. TNOSC DSD structure4-50

Figure 4-10. TNOSC DSD elements–TNT, TIC, and TLT with
corps/division.....4-52

Figure 4-11. TNOSC DSD elements–TNT, TIC, and TLT without
corps/division.....4-53

Figure 5-1. WIN-T Increment 1 architecture 5-3

Figure 5-2. Command post node 5-8

Figure 6-1. CSS VSAT architecture.....6-4

Figure 6-2. Trojan SPIRIT architecture.....6-5

Figure 6-3. GBS architecture6-10

Figure 6-4. Transportable ground receive suite.....6-14

Figure A-1. The electromagnetic spectrum A-2

Figure A-2. Army spectrum management process A-4

Figure A-3. Spectrum management radio
frequency systems A-5

Figure B-1. The Army battle command system B-2

Figure C-1. DA PAM 611-21 Web site page..... C-3

Figure D-1. OPORD paragraph 5, command
and signal outline D-2

Contents

Figure D-2. Outline of a signal annex D-3
Figure E-1. Two level maintenance process flow E-3
Figure E-2. BCT maintenance operations E-8

Tables

Table A-1. Spectrum management tools and descriptions..... A-6

Preface

This field manual is a pocket reference guide for signal Soldiers at all echelons. It is intended to help signal Soldiers understand and implement Army communications systems operations in a modular force construct.

This manual addresses the roles and responsibilities of the signal Soldier and signal planning during the military decision making process. It also provides an overview of the Global Information Grid, LandWarNet and its transport systems, network operations and spectrum management. It also addresses the transformed signal structure from the maneuver battalion through theater level and the support provided between echelons.

Note. As of June 2007, the Joint Network Node-Network program has been incorporated into the Warfighter Information Network-Tactical program and designated as Warfighter Information Network-Tactical Increment 1. When joint network node is used in this document, it refers to the equipment and not to the program.

This publication applies to the Active Army, the Army National Guard (ARNG)/Army National Guard of the United States (ARNGUS), and the United States Army Reserve (USAR) unless otherwise stated.

The proponent of this publication is the United States Army Training and Doctrine Command (TRADOC). The preparing agency of this publication is the US Army Signal Center.

Preface

Send comments and recommendations on DA Form 2028 (*Recommended Changes to Publications and Blank Forms*) via e-mail to signal.doctrine@us.army.mil. Key your comments and recommendations to pages and lines of text to which they apply. Provide reasons for your comments to ensure understanding and proper evaluation.

Mailing address is: Commander, United States Army Signal Center and Fort Gordon, ATTN: ATZH-IDC-CB (Doctrine Section), Building 29808, 506 Chamberlain Ave, Fort Gordon, GA 30905-5075.

Unless this publication states otherwise, masculine nouns and pronouns do not refer exclusively to men.

Introduction

The Army has decentralized most of its signal capabilities. Corps, divisions, brigade combat teams, and support brigades now have signal forces organic to the units who own, operate, train, and maintain their unique signal forces. Corps signal brigades and division signal battalions have inactivated leaving a large part of the Army force supported by pooled theater assets. Supporting the commander with reliable and vigorous communications is a direct result of detailed signal planning. Understanding the commander's intent is the most critical step for a signal leader.

Signal Soldiers and planners are chartered to build networks that almost intuitively act on behalf of the commander's intent; networks where information is guaranteed based on policies aligned with the commander's critical information requirements and intent. To build this network, planners must successfully synchronize and integrate the assets to support the plan and the commander. Signal Soldiers have the great responsibility to facilitate the combined arms, joint, and multinational fight. This mission is critical to increasing the combat power in the modular force. The signal planner plays a critical role in enabling combat successes and prevailing in the information war.

This page intentionally left blank.

Chapter 1

Signal Soldier's Roles and Responsibilities

The Army's transformation to a modular force has transformed the signal structure. Division signal battalions and corps signal brigades have been inactivated with the signal support now embedded within each modular organization. Division and corps are headquarters organizations with units attached as mission dictates and have signal companies assigned that support the headquarters element only. Each brigade combat team (BCT) or modular support brigade has its own organic signal company to provide support. This chapter addresses the roles and responsibilities of the signal Soldier to the commander and his responsibilities at each echelon.

SIGNAL SOLDIER RESPONSIBILITIES TO THE COMMANDER

1-1. The transformation to a modular Army and the elimination of the corps signal brigade and division signal battalion has removed the traditional support structure for the assistant chief of staff, network operations (G-6)/network operations staff officer (S-6). This has required the G-6/S-6 to build working relationships with organizations

Chapter 1

that have traditionally been provided by a signal brigade or battalion staff. The G-6/S-6 must establish a viable working relationship not only with the staff officers within his organization, but also with higher, lower, and adjacent organizations. These organizations include sustainment, signal, and other supported or supporting organizations that the G-6/S-6 is required to coordinate training or specific mission requirements.

1-2. The signal leader is responsible to the commander for the following—

- Reports the status of the units' communications and information system maintenance during briefings (information, decision, mission, and staff). He provides a status report of all the information systems on the local area network (LAN).
- Participates in the military decision making process (MDMP). (Refer to Field Manual [FM] 5-0 for more information on the MDMP.) As part of the commander's staff, the signal leader performs the following critical tasks during planning:
 - Develops and maintains running estimates.
 - Identifies specified and implied tasks.
 - Identifies constraints.
 - Identifies key facts and assumptions.
 - Performs intelligence preparation of the battlefield.
 - Formulates the concepts of operations and support in line with the commander's intent.
 - Develops the scheme of maneuver to support the course of action (COA).
 - Prepares, authenticates, and distributes his portion of the plan or order, annexes, estimates, appendixes, and supporting plans.
- During the development of the COA, assesses the communications feasibility of each COA. He determines the communications and computer requirements and compares them to available assets. He

Signal Soldier's Roles and Responsibilities

identifies potential shortfalls and recommends actions to eliminate or reduce their effect.

- Recommends commander's critical information requirements (CCIR). Commanders designate CCIR and essential elements of friendly information to let their staff and subordinates know what information they deem necessary for decision-making.
- Develops/Prepares signal sections of the unit standing operating procedures (SOP) in accordance with (IAW) the commander's intent.
- Completes or assists during staff studies and decision papers as necessary.

BATTALION S-6 OFFICER

1-3. The battalion S-6 officer and communications chief lead the Signal Regiment's front-line Soldiers. Battalions are equipped with network and systems enablers providing capabilities that in the past were only provided at echelons brigade and higher. These enablers (for example, Blue Force Tracking [BFT], combat service support [CSS] satellite communications [SATCOM], and the command post node [CPN]) require greater external coordination than earlier systems.

1-4. The battalion S-6 officer is responsible for the supervision of all automated information systems, network management, computer network defense (CND), electromagnetic spectrum operations (EMSO), and information assurance (IA). (Refer to Appendix A for more information on EMSO.) The primary signal operations planner is also an active member of the staff planning during the MDMP. He determines the supportability and feasibility of the signal plan versus the scheme of maneuver. Early involvement in the MDMP by the battalion S-6 officer is critical to the successful development of a comprehensive and complementary signal plan. (Refer to Chapter 2 for more information on the signal planning process.)

ROLES AND RESPONSIBILITIES

1-5. The battalion S-6 section is organized to support the commander's intent. The S-6 officer maintains overall authority and responsibility for the communications assets and operations within the battalion area of operations (AO).

1-6. As a principal staff officer, the battalion S-6 officer interacts closely with the battalion commander, executive officer, operations staff officer (S-3), and other staff officers to determine specific or unique communications and network requirements. The battalion S-6 officer must work closely with the brigade S-6 officer and adjacent headquarters to ensure efficient communications employment throughout the battalion AO. The S-6 officer is responsible for maintenance on organic signal systems within the battalion.

1-7. Each maneuver battalion is equipped with combat net radio (CNR) capabilities. The battalion provides primary internal communications and an organic CPN enables wideband beyond line of sight (BLOS) access to the brigade information network and limited Defense Information Systems Network (DISN) services (SECRET Internet Protocol Router Network [SIPRNET], Voice over Internet Protocol telephones, and Non-Secure Internet Protocol Router Network [NIPRNET]).

1-8. The battalion S-6 officer has the following responsibilities—

- Prepares, maintains, and updates communications operations estimates, plans, and orders. (These orders will often be cause for configuration management changes across the battalion.)
- Monitors and makes recommendations on all technical communications and information operations.
- Advises the commander, staff, and subordinate commanders on communications and information operations and network priorities for command and control (C2) (for example, changing bandwidth allocation to support a specific battalion mission).
- Works closely with the brigade S-6 in developing signal-operating instructions.

Signal Soldier's Roles and Responsibilities

- Prepares/publishes communication operations SOP for the battalion.
- Works closely with the brigade S-6 in the planning and management of BCT EMSO.
- Plans and coordinates with higher and lower headquarters regarding information systems upgrade, replacement, elimination, and integration.
- In coordination with the intelligence staff officer (S-2) and S-3, coordinates, plans, and directs all IA and CND activities and information operations vulnerability and risk assessments.
- In coordination with the staff, actively coordinates with the brigade S-6 to develop the information and communications plans, manage the information network, obtain required services, and support mission requirements.
- Confirms and validates user information requirements in direct response to the tactical mission.
- Establishes information policies and procedures for using and managing information tools and resources.
- Provides signal personnel with direction and guidance during preparation of network plans and diagrams establishing the information network.
- Plans and integrates information systems and Army Battle Command System (ABCS) equipment IAW unit task organization/reorganization. (See Appendix B for a detailed discussion on ABCS.)
- In coordination with the brigade S-6, plans and directs all network operations (NETOPS) activities within the battalion AO.
- Plans and monitors all battalion networks and manages the LAN utilizing the organic S-6 section personnel.
- Oversees communications security (COMSEC) operations to include storage, management, distribution, inspection, and compliance.
- Responsible for the field level maintenance on communications electronics (CE) systems.

TRAINING READINESS RESPONSIBILITIES

1-9. The battalion S-6 officer has the following training readiness responsibilities—

- In coordination with the brigade S-6 officer, ensures the development of required skills of all battalion signal personnel.
- In coordination with the personnel staff officer (S-1), identifies requirements and manages the distribution of signal personnel within the battalion. (Refer to Appendix C for more information on signal Soldier military occupational specialty [MOS], changes, and tasks.)
- In coordination with the S-3, monitors and provides oversight for information dissemination to change any warfighting functions, priorities, and control measures within the battalion.
- In coordination with the battalion S-6 staff, ensures automation systems and administration procedures for all automation hardware and software employed by the battalion is joint and Army compliant.

FUNCTIONAL RESPONSIBILITIES SUPPORTING THE BATTALION

1-10. The battalion S-6 officer is a principal coordinating staff officer. In this capacity, he works directly for the battalion executive officer. Additionally, he directly supports the executive officer's battalion maintenance plan (outlined later in this chapter under Network Systems Maintenance). There is also a close relationship between the battalion S-3 and S-6. The S-6 must understand the S-3s plans, thought process, and methodology to make the network react intuitively to support the fight.

BRIGADE S-6 OFFICER

1-11. The brigade S-6 officer, as a principal staff officer, interacts closely with the brigade commander, executive officer, operations staff officer (S-3), and other staff officers to determine specific or unique communications and network requirements. The brigade S-6 officer and his staff plan the communications and information systems support (to include EMSO) for the brigade, brigade command posts (CPs), and subordinate units organic to, assigned to, or operating within the brigade AO.

1-12. The brigade S-6 section is organized to best support the commander's intent. This section addresses the roles and responsibilities of the brigade S-6. Unless specifically noted, these roles and responsibilities apply to both the BCT S-6 officer and the modular support brigade S-6 officer.

1-13. Figure 1-1 depicts the BCT S-6 staff organization. This organization reflects the consolidation of the NETOPS section from the signal company to the S-6 to provide a more efficient organization and facilitate the S-6's ability to perform the critical functions required. The S-6 staff organization differs in the support brigades only in that there are two less 25L10J2.

1-14. The S-6 section personnel are located within the brigade CPs to support the commander's communications requirements across the AO. The brigade S-6 officer works closely with the division G-6 officer and brigade signal company commander.

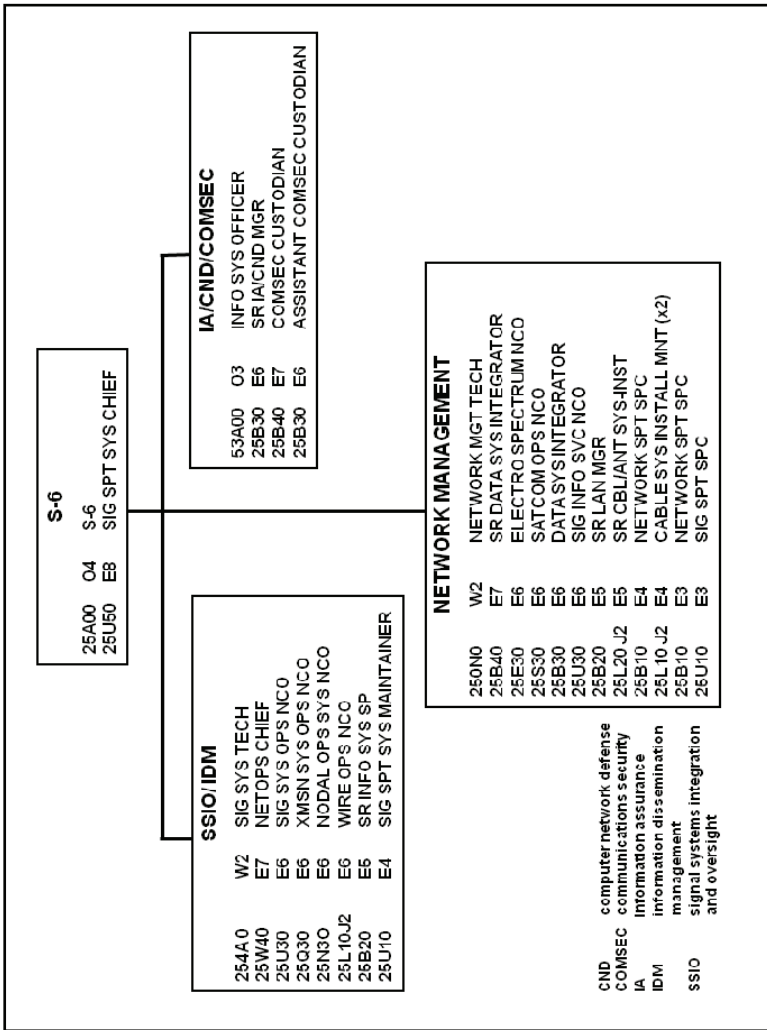

Figure 1-1. BCT S-6 staff organization

ROLES AND RESPONSIBILITIES

1-15. The brigade S-6 officer has the following responsibilities that reside in the network management and IA/CND/COMSEC cells—

- Prepares, maintains, and updates communications and information operations estimates, plans, and orders. Orders will often direct configuration management changes across multiple battalions.
- Monitors and makes recommendations on all technical communication and information operations.
- Can be designated as the Army forces (ARFOR) G-6 when needed. (Equipment and personnel augmentation will be required to support this mission.)
- Advises the commander, staff, and subordinate commanders on communication operations and network priorities for C2 (for example, changing bandwidth allocation to support the brigade main effort such as a battalion reinforced with additional intelligence, surveillance, and reconnaissance assets).
- Develops, produces, changes/updates, and distributes signal-operating instructions.
- Prepares/publishes communications operations SOP for brigade CPs.
- Coordinates, plans, and manages brigade EMSO within the brigade's AO.
- Plans and coordinates with higher and lower headquarters regarding information systems upgrades, replacements, eliminations, and integrations.
- In coordination with the operational chain of command and corps, plans and directs all NETOPS activities within the brigade AO.
- Plans, manages, and monitors all brigade CP networks using S-6 section personnel.
- Staffs and supervises the activities of the NETOPS cell in the network operations security center (NOSC).

Chapter 1

- Oversees COMSEC operations to include storage, management, distribution, inspection, and compliance.
- Responsible for the field level maintenance on CE systems.

1-16. The information systems officer is responsible to the S-6 for the following—

- In coordination with the S-2 and S-3, coordinates, plans, and directs all IA activities and information operations vulnerability and risk assessments.
- In coordination with the brigade S-6 staff, actively coordinates with a variety of external agencies to develop the information and communications plans, manages the information network, obtains required services, and supports mission requirements.
- Confirms and validates user information requirements in direct response to the tactical mission.
- Establishes information policies and procedures for using and managing information tools and resources.
- Provides signal unit operations sections with direction and guidance during preparation of network plans and diagrams establishing the information network.
- Ensures the accreditation and integration of all hardware and software in the AO connected to the LAN/wide area network (WAN).
- Plans and integrates information systems and ABCS equipment due to unit task organization/reorganization.

TRAINING READINESS RESPONSIBILITIES

1-17. The brigade S-6 officer has the following training readiness responsibilities and exercises them through the signal systems integration and oversight (SSIO) cell—

- In coordination with the division G-6, ensures the development of required skills of all signal personnel within the brigade AO.
- In coordination with the S-1, identifies requirements and manages the distribution of signal personnel within the brigade.

Signal Soldier's Roles and Responsibilities

- In coordination with the S-3, monitors and provides oversight for information dissemination to change warfighting functions priorities and control measures within the brigade AO.
- In coordination with the S-6 staff, ensures information systems and administration procedures for all automation hardware and software employed by the brigade are joint and Army compliant.
- In coordination with the brigade special troops battalion (BSTB) staff, ensures the brigade signal company is trained to support brigade missions and tasks.

1-18. When a BCT operates independently, the brigade S-6 officer performs all the duties and has the same responsibilities as a G-6 officer. These duties and responsibilities include—

- Coordinates, plans, and manages the brigade EMSO, both internal and external to the brigade.
- Plans and manages the brigade information network with the corps Service Theater Network Operations and Security Center (STNOSC), the corps supporting brigade, the regional Defense Information System Agency (DISA) support team, or the supported command, control, communications, and computer operations directorate of a joint staff (J-6).
- In coordination with strategic corps STNOSC and the corps-supporting brigade, plans and manages the brigade IA systems (firewalls, intrusion detection systems, and access control lists).
- Plans and manages the brigade information dissemination management/content staging procedures (user profiles, file and user priorities, and dissemination policies).
- Plans and manages all IA/CND operations to include, but not limited to, key management distribution, IA vulnerability alert compliance, intrusion detection device management and operations, and compliance with all directives.

Chapter 1

- Deploys range extension assets to maintain connectivity and reliability of the brigade information network.
- Evaluates network requirements to determine needs for unmanned aircraft system (brigade level) and communications relay requirements.

BRIGADE SIGNAL COMPANY ORGANIZATION

1-19. This section addresses brigade signal companies that are organic to the BCT; the brigade signal company that is organic to the maneuver enhancement brigade (MEB) and sustainment brigades; and the brigade signal company that is organic to the fires, combat aviation brigade, and the battlefield surveillance brigade. The three different brigade signal companies are designed with equipment and personnel to specifically support their designated brigade organizations.

1-20. The signal company within the heavy and infantry BCT is subordinate to the BSTB with the Stryker brigade combat team (SBCT) signal company being a separate company. The signal company organic to the BCT has a headquarters and two network support platoons. Figure 1-2 depicts the BCT signal company.

HEADQUARTERS AND NETWORK SUPPORT PLATOON

1-21. The headquarters and network support platoon within the BCT consists of the company headquarters, small CP support team(s), and wireless network extension team(s).

Company Headquarters

1-22. The company headquarters provides C2, logistics, and administrative support for the company and coordinates the maintenance support of CE systems with the brigade S-6.

Wireless Network Extension Team(s)

1-23. The wireless network extension team(s) within the brigade signal companies provides BLOS connectivity for the various CPs and C2 nodes.

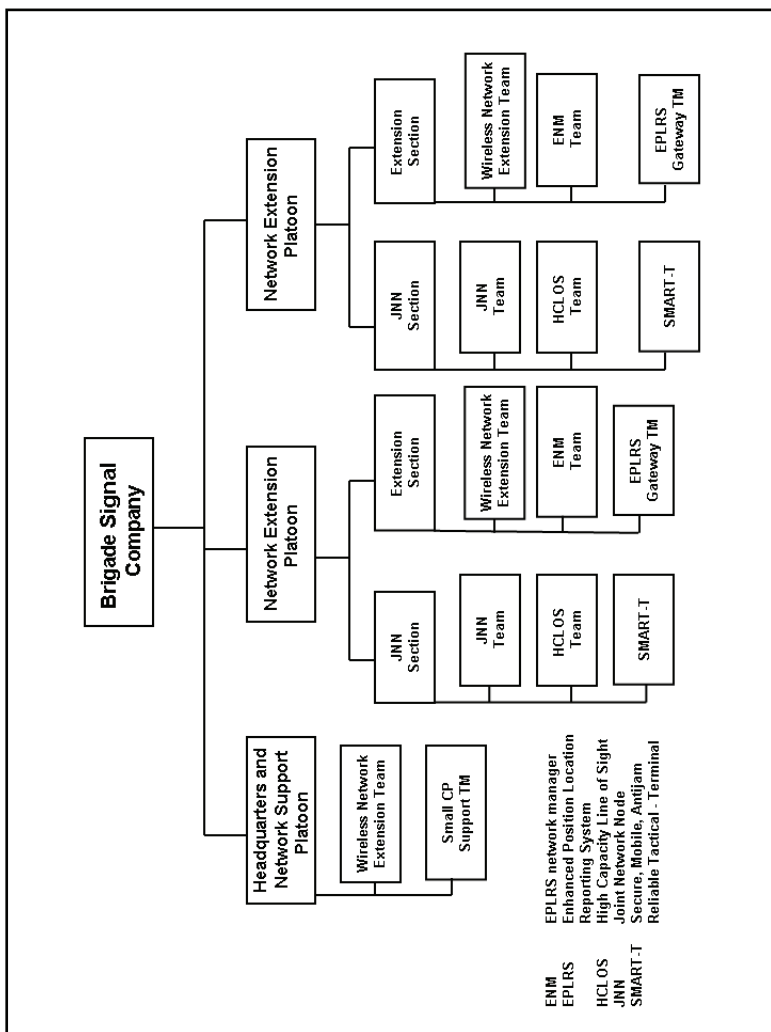

Figure 1-2. BCT signal company organizational structure

Small Command Post Support Team(s)

1-24. The small CP support team within the brigade signal company provides BLOS connectivity and tactical LAN support to the tactical CP and other C2 nodes.

NETWORK EXTENSION PLATOON

1-25. The network extension platoon consists of the joint network node (JNN) and extension sections and supports a major C2 node. There are two network extension platoons within the brigade signal company supporting the BCT: one network extension platoon supports the brigade main, and the other network extension platoon supports the brigade tactical CP (TAC CP).

Joint Network Node Section

1-26. The JNN section provides voice, video, and data services to the main and TAC CP. It provides habitual BLOS and line of sight (LOS) support to the main CP and TAC CP. The JNN can terminate circuits, provide data and battlefield video teleconferencing center connectivity to host equipment, and interface special circuits such as Defense Switched Network, North Atlantic Treaty Organization circuits, and commercial gateways.

Wireless Network Extension, Enhanced Position Location Reporting System Network Manager and Enhanced Position Location Reporting System Teams

1-27. The wireless network extension, Enhanced Position Location Reporting System (EPLRS) Network Manager and EPLRS teams provides frequency modulated (FM) wireless network extension, EPLRS network management, and an EPLRS gateway team for the assigned CP.

MODULAR SUPPORT BRIGADE SIGNAL COMPANIES

1-28. The sustainment brigade signal company is subordinate to the BSTB and the fires, combat aviation brigade, battlefield surveillance brigade, and MEB signal companies are separate companies within their respective brigades. The signal companies differ in structure only in that the signal company supporting the MEB, sustainment, and combat aviation brigade contains two small CP support teams vice one in the battlefield surveillance brigade and fires brigade signal companies. Figure 1-3 depicts the modular support brigades signal companies.

COMPANY HEADQUARTERS

1-29. The company headquarters provides C2, logistics, and administrative support for the company.

NETWORK EXTENSION PLATOON

1-30. The network extension platoon provides support to the brigade main CP.

Joint Network Node Section

1-31. The JNN team provides switching, satellite, and data package capabilities. The high-capacity line of sight (HCLOS) team provides LOS connectivity between brigade CPs and higher, adjacent, and subordinate units. The secure mobile anti-jam reliable tactical terminal (SMART-T) is a tactical SATCOM terminal that provides BLOS connectivity between the brigade and higher or adjacent headquarters.

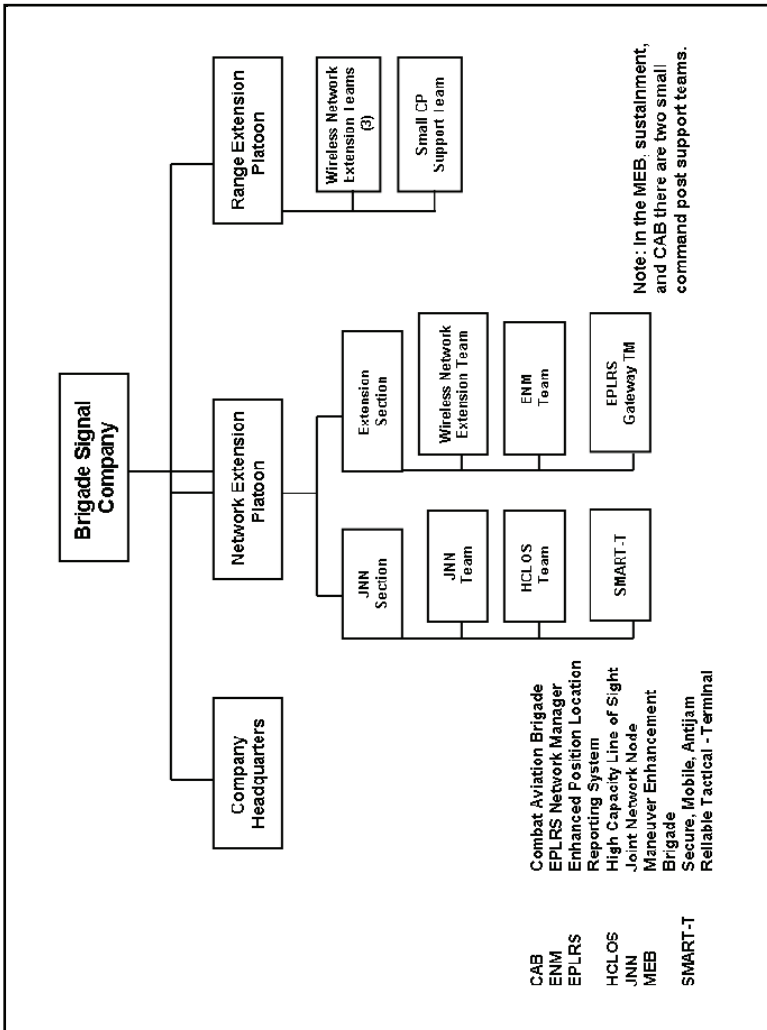

Figure 1-3. Modular support brigades signal company organizational structure

Extension Section

1-32. The extension section provides a wireless network extension team for range extension of the brigade Single Channel Ground and Airborne Radio System (SINCGARS) network and EPLRS teams to provide net control station and gateway capability for data reconstruction of EPLRS, near term digital radio, and SINCGARS data traffic.

RANGE EXTENSION PLATOON

1-33. The range extension platoon provides C2 for three SINCGARS wireless network extension teams for coverage of the brigade AO and small CP support teams that provide support for subordinate brigade CPs.

SIGNAL COMPANY COMMANDERS

1-34. The signal company commanders within the corps, division, and brigade share much the same organization and work closely with their respective G-6/S-6.

1-35. The signal company commander is responsible for the installation, operation, and maintenance of the information network. While the G-6/S-6 has authority over the network and recommends the emplacement and displacement of signal assets, the execution orders are developed and issued through the normal command channels, usually a fragmentary order (FRAGO) from the assistant chief of staff, operations (G-3)/S-3 directing movement. The authority over the signal company's assets is employed using TSOs, using the NETOPS functions and the applicable NOSC.

1-36. The signal company commander maintains command authority and is responsible for the health and welfare, training readiness and electronic and vehicle maintenance of all signal company personnel and equipment. The signal company commander directs the company's organic detachments and any attached or operational control (OPCON) elements.

1-37. The signal company commander in a modular support brigade has a unique challenge in that these support brigades are designed to support BCTs and may carry out specific tasks to support echelons above BCT. The support brigades are flexible organizations with additional capabilities added based on factors of mission, enemy, terrain and weather, troops and support available, time available and civil considerations (METT-TC). Thus, the signal company commander must support the brigade day-to-day mission as well as the mission of the organization the support brigade is attached to for specific operations.

S-6 and the Combat Service Support Automation Management Officer

1-38. The S-6 section assists the CSS automation management officer in troubleshooting mission application software problems. As system administrators and system/software security managers for sustainment hardware platforms, the CSS automation management officer will perform all tasks normally associated with information technology (IT) operations, ranging from issuing passwords to installing anti-virus software. They will assist and advise on turn-in procedures for line replaceable unit (LRU) items. The S-6 is responsible for maintaining, administering, and troubleshooting the network for the CSS automation management officer.

DIVISION COMMAND AND CONTROL

1-39. The division is the Army's primary tactical and operational warfighting headquarters. It is designed as a modular, C2 headquarters for full spectrum operations. When deployed, the division headquarters is organized around three C2 elements: the main CP, TAC CP, and a mobile command group (MCG).

DIVISION COMMAND POSTS

1-40. The design of the division gives the commander various options for the employment of the headquarters. The MCG is equipped to permit the division commander to reach any point in the division AO by ground or air and remain linked to the rest of the headquarters and to the common operational picture. The main CP can locate anywhere in the AO, remain linked to the operation, develop plans, conduct analysis, and provide detailed estimates. The TAC CP provides flexibility for training, readiness, and operations.

Main Command Post

1-41. The organic division signal company supports the main CP, but it requires longer set up and tear down time than the other CPs. Since there is a lengthier time required for setup and connectivity, the main CP normally deploys and sets up in a semi-stationary base within theater.

Tactical Command Post

1-42. The TAC CP is supported by the organic division signal company and has similar equipment. The TAC CP can rapidly tear down and setup, but is not equipped for battle command on the move. The TAC CP must halt to use full communications and network capabilities.

Mobile Command Group

1-43. The MCG has organic ground C2 vehicles, a small security force, and communications. The MCG staff is not fixed. The commander selects members of the division staff to fill the MCG seats. Given that the number of seats is limited by the ground and air systems, only two or three members of the division staff go with the MCG.

DEPLOYMENT OF DIVISION COMMAND POSTS

1-44. The combination of CPs allows the division commander to rotate readiness and training responsibilities while the division is in garrison. The TAC CP maintains a higher readiness posture and may configure equipment and personnel into an early entry CP package to fit constrained lift with the other equipment and personnel prepared to follow. The early entry CP may require augmentation from the main CP.

1-45. The MCG deploys following the introduction of subordinate forces into the joint operations area (JOA), and after the TAC CP is operational there. The commander may elect to deploy the MCG with the earliest deploying elements of the division or wait until the number of units has reached the level where the commander's presence is more important in the JOA than at the home station.

1-46. The main CP, less any individuals and equipment needed to augment the TAC CP to form the early entry CP, remains at home station during the initial phase of the deployment process. Once the early entry CP is established within the JOA of the gaining joint forces command, the commander deploys the main CP into the JOA. Normally the main CP deploys in at least two echelons.

G-6 RESPONSIBILITIES AT THE DIVISION COMMAND POSTS

1-47. The division G-6 has separate elements to support the main CP and TAC CP, though augmentation of the TAC CP is sometimes required due to METT-TC. The functions of the G-6 elements differ based on the responsibilities they are assigned.

DIVISION G-6 OFFICER ROLES AND RESPONSIBILITIES

1-48. The division G-6 officer is the senior signal officer who exercises staff oversight of the division information network. The G-6 officer possesses the expertise to anticipate the need for dynamically changing the network to support the division commanders' scheme of maneuver.

1-49. The G-6 officer derives his authority to control the network from the division commander; this authority empowers him to use all signal equipment and personnel to complete his mission. A successful mission implies that all signal-training requirements are met prior to employment. He controls these network assets via the NOSC and uses the TSO, much like the division G-3, uses the FRAGO to control the maneuver forces under the division. The G-6 officer's network responsibilities encompass all the management and control of the network. The NOSC enables the G-6 to monitor the health of the network in support of the command.

1-50. The G-6 officer is the principal staff officer for all matters concerning communications, EMSO, and networks. The G-6 officer has the technical oversight responsibility over the division information networks including training readiness responsibility of the division signal company. The G-6 officer is accountable for all network transport, network services, and the viability of information systems across the force.

1-51. By executing the commander's intent, the G-6 officer directs all technical changes to the network. To make physical moves to signal equipment, the G-6 officer recommends FRAGOs to direct such movement with the G-3. He is responsible for advising the division commander, staff, and subordinate commanders on communications and information operational matters (staff responsibilities, technical guidance, and training readiness responsibilities).

Chapter 1

1-52. The division G-6 officer has the following responsibilities—

- Prepares, maintains, and updates communications and information operations estimates, plans, and orders. These orders will often direct configuration management changes across multiple brigades.
- Monitors and makes recommendations on all technical communications and information operations.
- Acts as the ARFOR G-6 when needed (equipment and personnel augmentation may be required to support this mission).
- Advises the commander, staff, and subordinate commanders on communications operations and network priorities for C2 (for example, changing bandwidth allocation to support the division main effort—a brigade reinforced with additional intelligence, surveillance, and reconnaissance assets).
- Directs technical changes to all portions of the division network via the TSO process.
- Acts as the joint task force (JTF) J-6, if required. Equipment and personnel augmentation will be required to support this mission and will be provided by the theater-level units such as the theater G-6, a signal command (theater) (SC[T]), or a signal brigade/Army service component command (ASCC).
- Prepares and/or publishes communications operations SOPs for division CPs.
- Coordinates, plans, and manages division EMSO within the division AO.
- Plans and coordinates with higher and lower headquarters regarding information systems upgrade, replacement, elimination, and integration.
- In coordination with the assistant chief of staff, intelligence (G-2), G-3, assistant chief of staff, information operations (G-7), operational chain of command, and STNOSC, coordinates, plans, and directs all IA activities and information operations vulnerability and risk assessments.

Signal Soldier's Roles and Responsibilities

- In coordination with the division G-6 staff—
 - Actively coordinates with a variety of external agencies to develop the information and communications plans, manages the information network, obtains required services, and supports mission requirements.
 - Develops, produces, changes, and/or updates and distributes signal-operating instructions.
 - Confirms and validates user information requirements in direct response to the tactical mission.
- Establishes information policies and procedures for using and managing information tools and resources.
- Provides units assigned or attached to the division with direction and guidance during preparation of network plans and produces diagrams establishing the information network.
- Plans and integrates information systems and ABCS equipment due to unit task organization/reorganization.
- In coordination with the corps and JTF, plans and directs all NETOPS activities within the division AO.
- Coordinates the contractor support for CE systems within the division AO.

TRAINING READINESS RESPONSIBILITIES

1-53. The division G-6 officer has the following training readiness responsibilities—

- Ensures the development of required skills of all signal personnel within the division AO.
- In coordination with the assistant chief of staff, personnel (G-1), identifies requirements and manages the distribution of signal personnel within the division.

Chapter 1

- In coordination with the G-3, monitors and provides oversight for information dissemination to adjust to changing warfighting function priorities and control measures within the division AO.
- In coordination with the division G-6 staff, ensures automation systems and administration procedures for all automation hardware and software used by the division comply with the Global Information Grid (GIG) procedures and standards or Army specifications.
- Ensures, in coordination with the special troops battalion (STB) commander, the division signal company is trained to support division missions and tasks during home station training events and deployments.

DIVISION G-6 ORGANIZATION

1-54. The division G-6 is organized and resourced to provide NETOPS support to the division CPs (tactical, main, and MCG). The G-6 uses NETOPS functions to synchronize disparate division unit networks into one division information network, as a part of the LandWarNet (LWN) and GIG. The NETOPS functions performed in the subordinate support brigades and BCTs provide a second echelon of NETOPS management that the division G-6 coordinates as part of a greater NETOPS plan. The division G-6 has separate elements to support the main CP and TAC CP, though augmentation of the TAC CP is sometimes required due to METT-TC. The functions of the G-6 elements differ based on the responsibilities they are assigned. Figures 1-4 and 1-5 show the division G-6 section organization.

Signal Soldier's Roles and Responsibilities

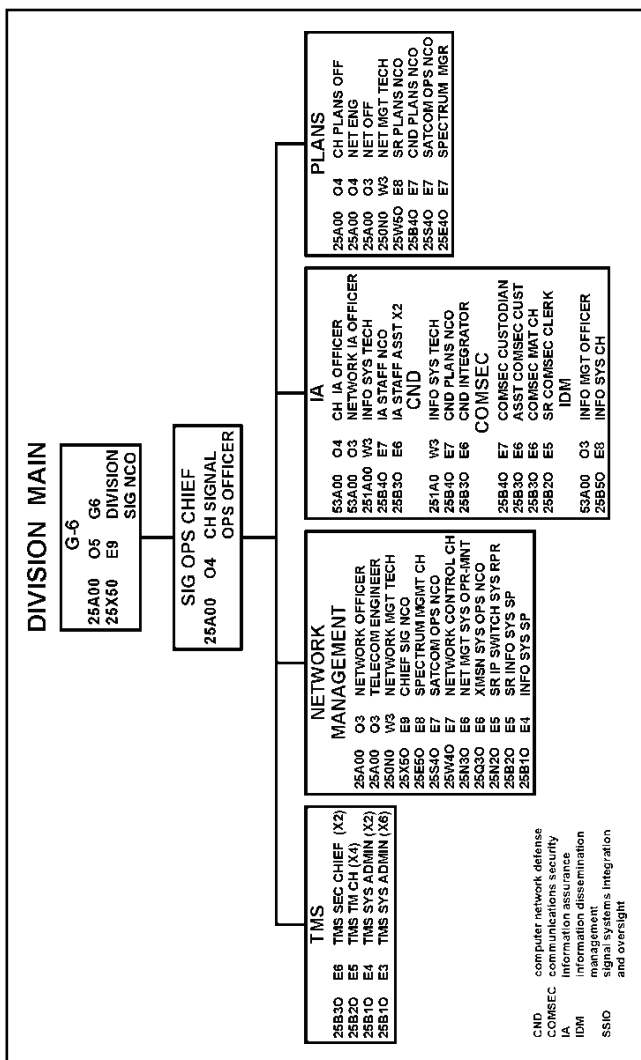

Figure 1-4. Division G-6 section organization

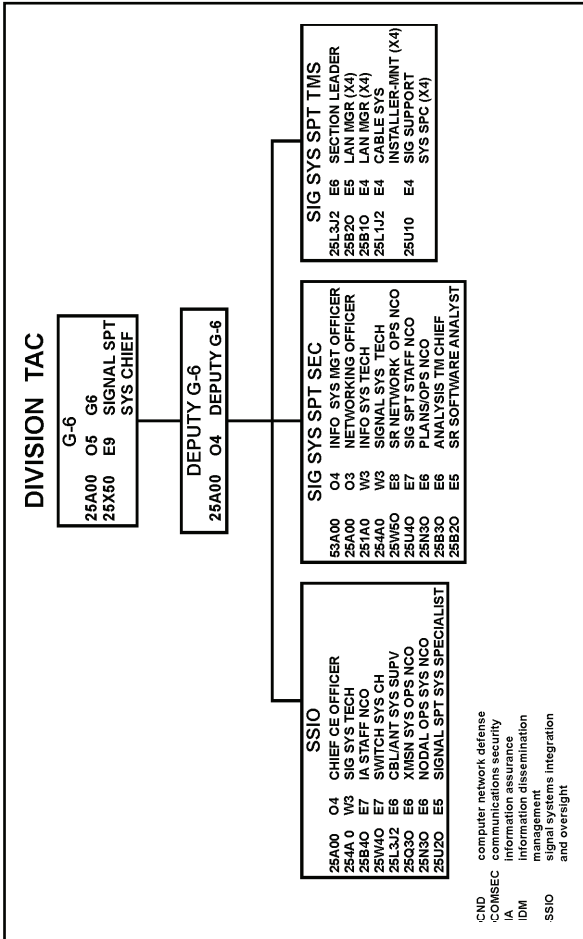

Figure 1-5. Division G-6 section organizations

G-6 Signal Operations

1-55. The signal operations section consists of a network management, plans, IA, and information dissemination management elements. The signal operations section has the following responsibilities—

- Integrates network management, information dissemination management, and IA functions.
- Maintains network connectivity across the division, to include units deployed to the AO, units en route to the AO, and units at the home station.
- Manages the division network from the applications residing on individual platforms through the points at which the division network connects to the GIG.
- Executes deliberate modifications to the division network to meet the needs of the commander.
- Manages requirements; accepts, validates, and tracks headquarters and subordinate unit communications requirements (computers, cell phones, radios, etc.).
- Monitors network performance.
- Manages the quality of service of the services provided through the division network, including the interoperability of the division network with external networks that are not controlled by the G-6 (for example, Global Broadcast System [GBS], Trojan Special Purpose Integrated Remote Intelligence Terminal [SPIRIT], and CSS very small aperture terminal [VSAT]).
- Coordinates satellite access requests and deconflicts frequencies.
- Resolves, reports, and coordinates with other agencies to resolve radio frequency conflicts.
- Secures access into the division network and monitors access and activities internal to the network.
- Provides situational awareness (SA) to the theater network operations security center (TNOSC) and SA/network common operating picture to authorized division recipients.

Chapter 1

- Ensures compliance with GIG network defense policies and JTF-global NETOPS/TNOSC GIG network defense communications tasking orders and or telecommunications service orders (TSOs).
- Prepares, maintains and updates command information management estimates, plans, and orders.
- In coordination with the G-3, establishes procedures for using relevant information and information systems to develop the common operational picture.
- Coordinates, plans, and directs the development of the common operational picture within the main CP.
- Coordinates with staff sections to ensure information quality criteria (accuracy, timeliness, usability, completeness, precision, and reliability) are maintained.
- Coordinates local information network capabilities and services.
- Monitors and reports status of information network; coordinates future network connectivity.
- Coordinates future communications and information operations interface with joint and multinational forces to include host nation.
- Provides EMSO.
- Develops and publishes Annex K to the division operation order (OPORD).
- Plans the transition of responsibility for the tactical network from the division to permanent theater signal assets (integrated theater signal battalion or commercial/contract).

G-6 Signal System Integration Oversight Section

1-56. The signal system integration oversight section performs the following functions—

- Oversees network certification for division units.
- Coordinates and tracks communications systems modernization.
- Coordinates and tracks communications systems maintenance.
- Oversees contractor support.
- Coordinates and tracks communications maintenance.

Signal Soldier's Roles and Responsibilities

- Coordinates collective communications systems training.
- Coordinates communications systems commercialization.
- Coordinates division communications readiness exercises.
- Training readiness responsibility for division headquarters and assigned unit JNN teams.
- Oversees the installation of division CP wire and cable, to include cable system installation in fixed facilities,
- Coordinates field level maintenance support for commercial off-the-shelf (COTS) and government off-the-shelf systems.

G-6 Signal System Support Section

1-57. The G-6 signal system support section supports the TAC CP to temporarily assume C2 of current operations, future operations, plans and analysis, or C2 of specific tasks while the main CP is either emplacing or displacing. When not deployed, the TAC falls in on and reinforces the capabilities of the main CP. The employment of the signal system support teams is METT-TC dependent. These teams support the main and TAC CPs as needed. The G-6 signal system support section performs the following functions for the tactical CP—

- Manages the local equipment and facilities that collect, process, store, display, and disseminate information, including computers (hardware and software) and communications as well as policies and procedures for their use.
- Monitors, manages, and controls organic communications systems that interface with the GIG.
- Performs tactical NETOPS functions (network management, information dissemination management, IA).
- Manages a set of integrated applications, processes, and services that provide the capability for producers and users to locate, retrieve, and send/receive information.
- Install, operate, maintain, and defend server data (SIPRNET) and military Internet (NIPRNET) in support of the division CP operations.

Chapter 1

- Manage installation and operation of the LAN, to include cable/wire installation and troubleshooting.
- Install CP cable and wire; coordinates and supervises team members in the construction, installation, and recovery of cable and wire communications systems and auxiliary equipment within division CPs.
- Forms a portion of the division Information Service Support Office.
- Installs and operates the division's IT help desk; provides e-mail assistance and other help desk functions.
- Assist division units with network installation and troubleshooting as directed by the G-6.

DIVISION NETWORK OPERATIONS SECURITY CENTER

1-58. The division G-6 officer is responsible for the employment of a fully integrated NOSC providing NETOPS functions for the division. All division signal elements must coordinate with the division NOSC during the engineering, installation, operation, maintenance, and defense of the division information network.

1-59. The division NOSC has overall responsibility for establishing the division information network and providing the operational and technical support to all units assigned or attached to the division operating in the AO.

1-60. The division NOSC performs the NETOPS activities, functions, and tasks required to create a dynamic and responsive network. This network also quickly shifts priorities in order to support the ground tactical plan. This management function extends the strategic GIG capabilities into responsive, dynamic, and tactical formations.

1-61. In order to increase responsiveness of a complex network and to facilitate the bandwidth required to support the division headquarters and brigade networks, the division employs a NETOPS cell with the regional network service center. The regional network service center flattens disparate time division multiple access (TDMA) satellite

Signal Soldier's Roles and Responsibilities

network structure and increases the bandwidth capability from approximately 6–40 megabits per second (Mbps). The embedded NETOPS cell provides the management to enable the division network.

1-62. In addition, by expanding bandwidth, the division has the capability to dynamically reassign the bandwidth so that the communications support plan can match the division commander's ground tactical plan. An example of this capability is the division designating a BCT as the main effort for an assault. The division commander's primary effort is to give the BCT a direct unmanned aircraft system/sensor feed that must be broadcasted across the entire network. The division G-6 matches the communications support plan enabling the added, nonorganic capability by allocating a larger segment of the division-enabled bandwidth.

1-63. The following are the division NOSC responsibilities—

- In coordination with the operational chain of command, STNOSC, and subordinate organizations, monitors, manages, and ensures implementation of enterprise system management/network management, information dissemination management/content staging, and IA/CND activities.
- Provides near real-time awareness of division networks and systems to the division G-6 and STNOSC.
- Coordinates actions to resolve attacks/incidents on the division network with the STNOSC and subordinate organizations.
- Coordinates operational procedures and requirements for IA/CND and information systems security with the supporting Army service component command regional computer emergency response team.
- In coordination with division signal company, monitors, manages, and controls intra-division information network components.
- Monitors the operation of the networks in the division's subordinate units.
- Provides support and assistance to the subordinate NOSCs as required.

Chapter 1

- Administers the organizational message system (defense message system [DMS]) in the division, including managing network addresses and sub-domains.
- Coordinates operation and maintenance support of communications systems. These systems are attached to support deployed division forces with the split-base and reach operations capability to the home base.
- Shares enterprise system management/network management information with other management or monitoring centers.
- Provides the supporting STNOSC and ARFOR NOSC with near real-time information on the status and performance of intra-division networks.
- Orders and accounts for all forms of COMSEC material, including storing keys in encrypted form and performing key generation and automatic key distribution.
- Performs COMSEC material accounting functions and communicates with other COMSEC elements.
- Performs content staging/information dissemination management functions to support all aspects of relevant information dissemination.
- Provides near real-time awareness of division networks and systems that support the joint backbone to the JTF Joint Network Operations Control Center (JNCC) when the division is serving as the ARFOR.

G-6 AND THE MOBILE COMMAND GROUP

1-64. The G-6 may or may not be a participant in the MCG. Since there is limited space for division staff, it is up to the division commander as to the specific composition of the MCG. If the G-6 or his representative does participate in the MCG, his responsibilities will vary and depend on how the MCG operates (ground or air) and from what location. The G-6 will have minimal network access and virtually no network management tools beyond those contained in his vehicle. Available MCG communications systems will include voice and data.

DIVISION SIGNAL COMPANY ROLES AND RESPONSIBILITIES

1-65. The division signal company provides 24-hour operations supporting the division headquarters. It provides operational elements designed to engineer, install, operate, maintain, and defend the joint theater network supporting division operations as an integral part of the division, theater army, ARFOR, or JTF IAW technical guidance provided by the division G-6 officer.

1-66. This support creates responsive redirection of network priorities, policies, and allocations to better support tactical operations in the division or subordinate brigades. The division G6 (assistant chief of staff, network operations) officer's technical oversight ensures the division network personnel and equipment are trained and maintained at the levels required to be successful.

DIVISION SIGNAL COMPANY ORGANIZATION

1-67. The division signal company is subordinate to the STB and consists of the headquarters, G-6 and signal detachment. To ensure the division commanders' intent is met, the division signal company operates under the authority of the division G-6 officer where the G-6 controls all NETOPS. Figure 1-6 provides a diagram of the division signal company organization.

1-68. The company is commanded by a major with a sergeant major assigned as the chief signal NCO and the signal detachment is assigned a captain and first sergeant. The G-6 is comprised of the staff G-6 section previously addressed. The signal detachment contains the elements necessary to support the main and TAC CPs and addressed here.

1-69. The company headquarters provides command, control, and command supervision of signal detachments assigned or attached to the company. The headquarters section is responsible for implementation of operations and intelligence directives received from higher headquarters.

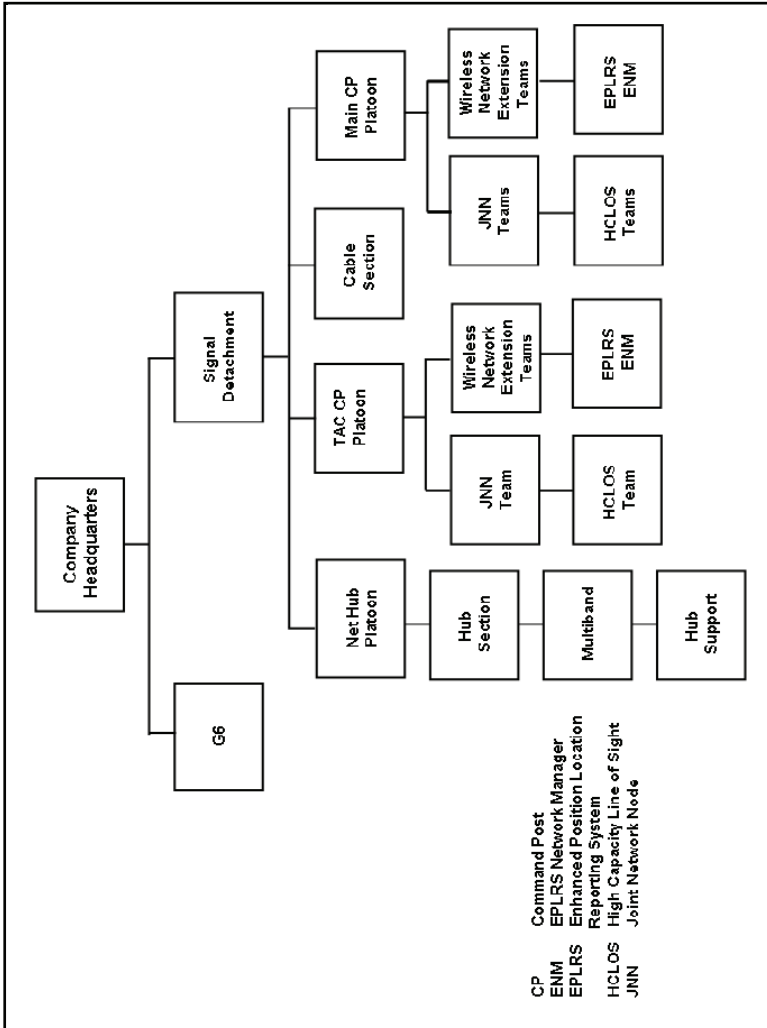

Figure 1-6. Division signal company organization

1-70. The signal company commander maintains command authority and is responsible for the health and welfare, training readiness, and electronic and vehicle maintenance of all signal company personnel and equipment. The signal company commander directs the company's organic detachments and any attached elements.

Signal Detachment

1-71. The signal detachment is modular and can deploy and support the division main and TAC CP LWN systems. It is composed of multiple voice and data sub-networks providing information exchange among division elements. The sub-networks overlap by echelon to provide survivable and robust networks.

1-72. The signal detachment headquarters provides for command, control, and coordination of the detachment mission. It is designed to provide command, control, and supervision to the three platoons that provide communications support to the division main and TAC CP.

1-73. The company headquarters provides C2 to the company. The headquarters is responsible for administration and logistics support. The detachment headquarters provides the detachment C2 and limited NETOPS support.

1-74. The network hub platoon consists of the TDMA and frequency division multiple access (FDMA) multiband sections and the baseband and hub support sections. It installs, operates, and maintains the network hubs and satellite connectivity to the GIG.

Main CP and TAC CP platoons

1-75. The main CP and TAC CP platoons support the division and TAC CPs. These platoons differ in that the main CP platoon has an additional JNN, HCLOS, and SMART-T team assigned to it. These platoons have capabilities and personnel to provide the following services—

- BLOS and LOS connectivity.
- Secure voice (tactical and Defense Switched Network).

Chapter 1

- NIPRNET, SIPRNET, and Joint Worldwide Intelligence Communications System (limited).
- Defense Red Switch Network.
- Video teleconferencing.
- Installation and administration of CP networks.
- Voice radio (single channel SATCOM, high frequency, and SINCGARS).
- Voice radio range extension.
- Help desk.
- Performs field level maintenance on CE systems.

Network Hub Platoon

1-76. The network hub platoon provides the division tactical hub node (THN) necessary to connect and make use of DISN/GIG services. The division tactical hubs provide TDMA and FDMA satellite connectivity. The network hub platoon consists of the TDMA and FDMA multiband section, the Baseband and Hub Support Sections. It installs, operates and maintains the network hub and satellite connectivity to the GIG.

Cable Section

1-77. The cable section assists the data support teams at the division main and TAC CPs as needed to establish the division infrastructure and inside cable functions.

THE CORPS

Note. The headquarters design and unit structure of the corps is pending review, information in this manual represents the latest information available.

1-78. The corps headquarters is being restructured to fill four primary roles. The corps headquarters primarily serves as an intermediate tactical headquarters in a major combat operation (MCO), but it may be used as an ARFOR headquarters, JTF headquarters, or Joint Force Land Component Command (JFLCC) headquarters.

1-79. The corps headquarters has essential C2 capabilities and is rapidly deployable to provide C2 for Army, joint, and multinational forces engaged in operations. The corps headquarters does not have any organic troops other than the STB. It can control any mix of modular brigades and divisions.

CORPS COMMAND POSTS

1-80. The modular corps design, combined with robust communications, gives the corps commander a flexible CP structure. Like the division, the corps has three CPs: main CP, TAC CP, and MCG.

MAIN COMMAND POST

1-81. The main CP is responsible for the continuity of corps operations. It synchronizes the conduct of corps current operations and allocates available resources. It oversees the future planning, analysis for current and future operations, sustainment coordination, and other staff functions. The main CP is much larger than the TAC CP and is organized into a mix of warfighting functions and integrating cells for staff communications and interaction. All warfighting functions are represented or available to serve temporarily in the current operations and plans integrating cells.

TACTICAL COMMAND POST

1-82. The corps TAC CP is organized as a current operations integrating cell. It can control the corps operations for a limited amount of time when the main CP is unavailable. The TAC CP may be used to control combinations of operations involving subordinate units, such as

Chapter 1

river crossings, passage of lines, and relief in place. The TAC CP receives a task-organized support element of communications and life support provided by the headquarters battalion.

Mobile Command Group

1-83. The MCG has organic ground C2 vehicles, a small security force, and communications. The MCG staff is not fixed. The corps commander selects members of the corps staff based on the situation. The corps signal company provides communications capabilities.

Early Entry Command Post

1-84. The early entry CP is an ad hoc organization comprised of equipment and personnel from the staff of the main and TAC CPs. The early entry CP is staffed with a mix of current operations personnel and planners able to coordinate the reception of the corps and plan its initial operations.

G-6 RESPONSIBILITIES AT THE CORPS COMMAND POSTS

1-85. The corps G-6 has separate elements to support the main CP and TAC CP, though augmentation of the TAC CP is sometimes required due to METT-TC. The functions of the G-6 elements differ based on the responsibilities they are assigned. In addition, the composition of the G-6 may be augmented depending on the situation and the role the corps is assigned. The MCG and early entry CP have no fixed organization and their composition will depend on METT-TC. Figures 1-7 and 1-8 shows the corps G-6 section organization.

Signal Soldier's Roles and Responsibilities

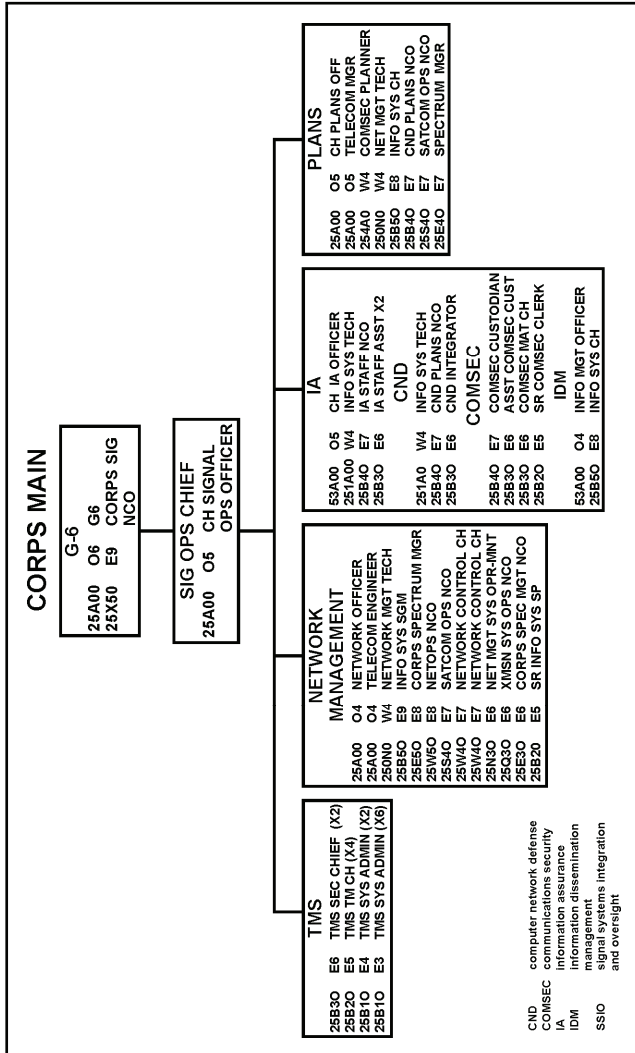

Figure 1-7. Corps G6 section organization

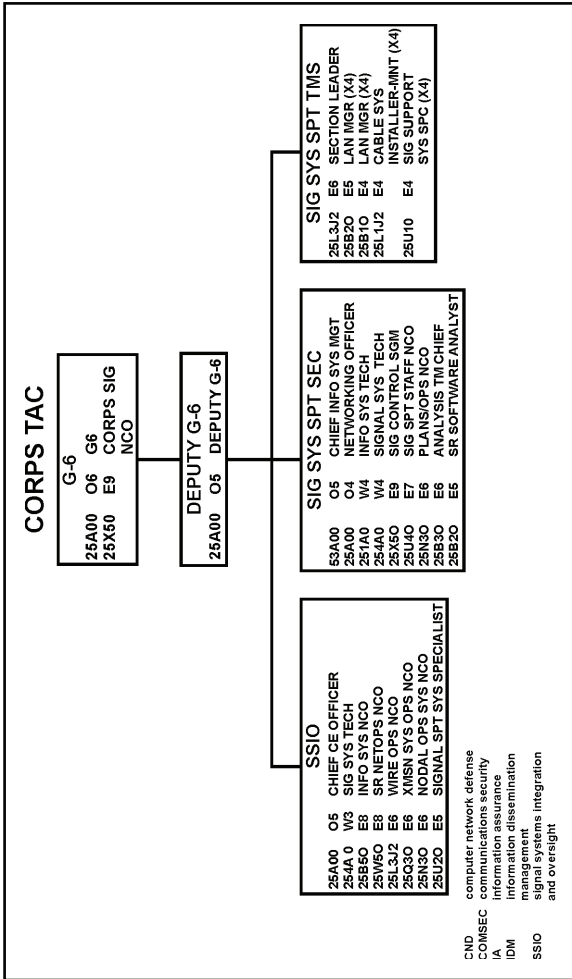

Figure 1-8. Corps G6 section organization

CORPS G-6 OFFICER

1-86. The corps G-6 officer is the principal staff officer for all matters concerning communications, EMSO, and networks. The G-6 officer has authority over the corps information networks including training readiness responsibility of the corps signal company. The G-6 is responsible for planning, designing, and directing the corps signal company to execute the communications plan to support the corps commander's intent. By executing the commander's intent, the G-6 directs all technical changes to the network.

1-87. To make physical moves to signal equipment, the G-6 recommends FRAGOs to direct such movement with the G-3. He is responsible for advising the corps commander, staff, and subordinate commanders on communications operational matters.

ROLES AND RESPONSIBILITIES

1-88. The corps G-6 officer has the following roles and responsibilities—

- Prepares, maintains, and updates communications operations estimates, plans, and orders. These orders will often cause configuration management changes across multiple brigades. (See Appendix D for a sample Signal Annex to an OPORD.)
- Monitors and makes recommendations on all technical communications and information operations.
- Advises the commander, staff, and subordinate commanders on communications and information operations and network priorities for C2 (for example, changing bandwidth allocation to support the corps main effort or a brigade reinforced with additional intelligence, surveillance, and reconnaissance assets).
- Directs technical changes to all portions of the corps network via the TSO process.
- Develops, produces, changes/updates, and distributes signal operating instruction material.

Chapter 1

- Prepares/publishes communications operations SOPs for corps CPs.
- Coordinates, plans, and manages corps EMSO within the corps AO.
- Plans and coordinates with higher and lower headquarters regarding information systems upgrades, replacements, eliminations, and integrations.
- In coordination with the G-2, G-3, G-7 operational chain of command, and STNOSC, plans and directs all IA activities and information operations vulnerability and risk assessments.
- In coordination with the staff, actively coordinates with a variety of external agencies to develop the information and communications plans, manages the information network, obtains required services, and supports mission requirements.
- Confirms and validates user information requirements in direct response to a tactical mission.
- Establishes communications and information policies and procedures for using and managing information tools and resources.
- Acts as the JFLCC J-6 officer, if required. Equipment and personnel augmentation will be required to support this mission and will be provided by theater as necessary.
- Provides signal unit operations sections with direction and guidance during preparation of network plans and produces diagrams establishing the information WAN.
- Plans and integrates information systems and ABCS equipment due to unit task organization/reorganization.
- In coordination with the JTF, plans and directs all NETOPS activities within the corps AO.

TRAINING READINESS RESPONSIBILITIES

1-89. The corps G-6 officer has the following training readiness responsibilities—

- Ensures the development of required skills of all signal personnel within the corps AO.
- In coordination with the G-1, identifies requirements and manages the distribution of signal personnel within the corps.
- In coordination with the G-3, monitors and provides oversight for information dissemination to change warfighting functions, priorities, and control measures within the corps AO.
- Ensures automation systems and administration procedures for all automation hardware and software used by the corps comply with the GIG procedures and standards or Army specifications.
- In coordination with the STB staff, ensures the corps signal company is trained to support corps missions and tasks.

CORPS G-6 OFFICER AND THE NOSC

1-90. The corps G-6 officer employs a fully integrated NOSC providing NETOPS functions for the corps. All corps signal elements must coordinate with the NOSC during the engineering, installation, operation, maintenance, and defense of the corps information network.

1-91. The corps NOSC has overall responsibility for establishing the corps information network and provides the operational and technical support to all of the corps signal elements in its AO.

1-92. The corps NOSC performs the NETOPS activities, functions, and tasks required to create a dynamic and responsive network. This network also quickly shifts priorities to support the ground tactical plan. This management function extends the strategic GIG's capabilities into responsive, dynamic, and tactical formations.

Chapter 1

1-93. The corps NOSC has the following responsibilities—

- In coordination with the operational chain of command, STNOSC, and subordinate organizations, monitors, manages, and ensures implementation of enterprise system management/network management, information dissemination management/content staging, and IA/CND activities.
- Coordinates actions to resolve attacks/incidents on the corps network with the STNOSC and subordinate organizations.
- Coordinates operational procedures and requirements for IA/CND and information systems security with the operational chain of command and supporting regional computer emergency response team.
- In coordination with the corps signal company commander, monitors, manages, and controls intra-corps information network components.
- Monitors the operation of the networks in the corps units.
- Provides support and assistance to the subordinate NOSCs, as required.
- Administers the organizational message system (DMS) in the corps, including managing network addresses and sub-domains.
- Coordinates operation and maintenance support of communications systems.
- Shares enterprise system management/network management information with other management or monitoring centers.
- Provides the supporting STNOSC and ARFOR NOSC with near real-time information on the status and performance of corps networks.
- Orders and accounts for all forms of COMSEC material, including storing keys in encrypted form and performing key generation and automatic key distribution.
- Performs COMSEC material accounting functions and communicates with other COMSEC elements.

Signal Soldier's Roles and Responsibilities

- Performs information dissemination management/content staging functions to support all aspects of relevant information dissemination.
- Provides near real-time awareness of corps networks and systems that support the joint backbone to the JTF JNCC when the corps is serving as the ARFOR/JFLCC.

CORPS G-6 OFFICER AS JOINT FORCE LAND COMPONENT COMMAND J-6 RESPONSIBILITIES

1-94. The JTF J-6 officer is responsible to the commander, JTF, for—

- Determining personnel requirements, including the number of personnel, grade, and clearance, and any personnel peculiarities for the directorate. Forwarding these requirements to the JTF personnel directorate of a joint staff (J-1) with appropriate billet description and justification.
- Providing the communications system to support reliable, timely information flow in support of joint operations. This includes the development of communications systems architectures and plans, as well as policy, guidance, and instructions for the integration and installation of operational communications systems.
- The JTF J-6 officer exercises staff supervision of all communications systems assets. This also includes Chairman, Joint Chiefs of Staff controlled transportable assets, automated information systems, COMSEC, and networks necessary to accomplish the overall joint force mission.
- Ensuring that subordinate service and/or component headquarters establish network management and control centers. The JTF J-6 officer establishes clear lines of communications and reporting obligations between control centers. Each element of the JTF must have clearly defined missions and responsible areas within the network.

Chapter 1

- Coordinating cross-service agreements between the JTF headquarters, component planners, and the JNCC. The JTF J-6 officer establishes a JNCC to manage all communications systems deployed during operations and exercises. The JNCC:
 - Exercises control and technical management over communications control centers belonging to deployed components and subordinate commands.
 - Serves as the single control agency for management and operational direction of the joint communications networks and infrastructure.
 - Performs planning, execution, technical, and management functions.
 - Develops/disseminates standards and procedures and collects and presents communications system management statistical data. The JNCC manages all tactical communications systems and strategic communications connectivity as defined by the joint operational architecture.
- Reviewing all communications systems plans prepared by subordinate component commanders. The JTF J-6 facilitates the execution of all communications systems actions to maximize support to the commander JTF and adjudicates any conflicts.

NETWORK SYSTEMS MAINTENANCE

1-95. Army transformation presents challenges for signal leaders and staff requiring greater coordination to ensure success of the network. The challenge centers on the G-6, S-6, and division/brigade signal company leadership. Overcoming the challenge requires working through the organizational boundaries of the respective STB, and brigades to sustain the LWN. Refer to Appendix E for detailed maintenance information.

ARMY FORCE GENERATION MODEL

1-96. The Army force generation model is the structured progression of increased unit readiness over time resulting in recurring periods of availability of trained, ready, and cohesive units prepared for operational deployment in support of civil authorities and combatant commander (CCDR) requirements.

1-97. The Army force generation model cycles Army brigades through three force pools of progressive readiness over a specified time—currently three years for the Active Army and six years for the Reserve Component. This goal has not yet been attained. These three force pools are reset/train, ready, and available. Throughout the process, an attempt is made to stabilize assigned personnel for the duration of the readiness cycle.

RESET/TRAIN

1-98. Units enter the reset/train force pool when they redeploy from long-term operations or complete their planned deployment window in the available force pool. Reset is a series of actions taken to restore units to a desired level of combat capability commensurate with mission requirements and available resources.

READY FORCE POOL

1-99. Units in the ready force pool are available for full spectrum operations. They may be mobilized and can be committed to meet operational requirements. Deploying units from the ready force pool constitute a surge. Units continue their structured progression of collective training to achieve the higher theater or core mission essential task list capability for full spectrum operations. Units move from ready to the available force pool when commanders assess they have met designated capability levels and the units have entered their designated window for deployment.

AVAILABLE FORCE POOL

1-100. Units in the available force pool are at the highest state of training and readiness levels and the first to be considered for sourcing operational requirements. All Active Army and Reserve Component rotational units pass through the one-year available force pool window when they may deploy to meet an operational requirement or remain focused on a specific contingency requirement.

Chapter 2

Signal Planning Process

The G-6/S-6 uses a warning order (WARNO) to initiate the signal planning process. The G-6/S-6 gathers general information on the initial who, what, when, and where and of the proposed operation. This chapter covers the necessary steps that effectively execute the signal planning process.

SIGNAL LEADER'S ROLE IN THE MILITARY DECISION MAKING PROCESS

2-1. The G-6/S-6 is the principal staff officer for all matters concerning signal operations, automation and network management, and information security. The G-6/S-6 initiates the signal planning process, to support the MDMP, when the WARNO is received. He coordinates with all the elements involved in the proposed operation. The signal steps, actions, and events discussed below are critical to mission success of the MDMP.

Note. Appendix D is a sample signal annex to an OPORD. Refer to FM 5-0 for an in-depth explanation of an OPORD.

STEP ONE: RECEIPT OF THE MISSION

2-2. Once the mission is received and the staff is alerted, the staff gathers the tools to begin planning and conducting an initial assessment

Chapter 2

of the mission. If there is a higher headquarters operation plan, read the base order, review Annex C (Operational Graphics), Annex A (Task Organization), the signal annex, and other annexes as needed. The G-6/S-6 will extract specified, implied, and essential tasks as well as any facts, assumptions, and constraints that apply to the G-6/S-6 staff. The staff will continue to develop running estimates and prepare WARNO (number one) with the intent of coming back together and consolidating each section's work on the overall mission analysis briefing for the commander and staff.

WARNO (Number One)

2-3. WARNO (number one) is a preliminary notice of an order to action, which determines if a unit is slated for a possible deployment. It also includes pertinent information such as—

- Analysis of the AO.
- General enemy and friendly situation.
- Attachments/detachments.
- Type and time of operation.
- Tentative time line.
- Security, movement, and/or reconnaissance instruction.
- Other pertinent information.

2-4. WARNO (number one) may also include specific communications elements that the S-6/G-6 may receive as an attachment (for example, a tactical satellite [TACSAT] operator). These assets are often task organized to brigade and battalion level. If new COMSEC material must be requested, then that information should be listed in the WARNO. Specific communication and C2 information in the WARNO may include—

- Attached communications assets.
- Specific equipment (what type, where and when it needs to be picked up, if applicable).
- Date and time of digital C2 rehearsal or communications exercise (if known).

- Type of COMSEC to be used.
- CP positioning.
- Specific communications or C2 guidance.
- Succession of command.

Initial Planning

2-5. The S-6 must also brief the communications chief/section so they can begin to execute their initial deployment preparation as defined in the unit SOP.

Request For Information

2-6. A request for information (RFI) is sent to a higher headquarters for clarification of an issue (unit SOP should specify a means for submitting and tracking RFIs). RFIs should be quality controlled, tracked, and consolidated in one location. An RFI manager (usually in the S-3 section) should consolidate similar information request from multiple elements. The G-6/S-6 should also track his own RFIs.

STEP TWO: CONDUCT MISSION ANALYSIS

2-7. During the mission analysis the S-6/G-6 will conduct the following tasks—

- Determine how much time he has to complete the mission.
- Analyze the order form higher headquarters.
- Coordinate with adjacent, higher, and lower unit S-6s.
- Complete a signal staff estimate.
- Conduct a signal site analysis describing how the terrain, weather, and enemy will affect the mission. Include wideband versus narrowband in the analysis.
- Capture any signal-specific guidance.
- Identify facts and assumptions.
- Identify specified, implied, and essential tasks.
- Provide input to WARNO (number two).

Chapter 2

Effective Mission Analysis

2-8. Conducting effective mission analysis is the key to the G-6/S-6 successfully providing signal support to the unit and providing the G-6/S-6 with a voice in the planning process. Many G-6s/S-6s fail to have the necessary tools to conduct an effective mission analysis, which may lead to a signal support plan that is developed after a COA has been selected. This failure leaves the S-6 scrambling to support the COA that may not be supportable.

Time Management and Coordination

2-9. The G-6/S-6 must determine how much time he has to complete the mission analysis based on the time line published by the executive officer. If no guidance is issued, ask. Ideally, the commander has issued his guidance, the executive officer has published a time line, and the staff has issued WARNO (number one). This early in the process the commander often may not be able to provide specific guidance.

Signal Staff Estimate

2-10. The G-6/S-6 should complete a signal staff estimate. It is based on the G-6/S-6 ability to support, compare, and approve friendly COAs. The estimate includes all of the signal information including, at a minimum, a signal mission analysis chart (which will outline what signal equipment is on-hand, in-use, non-mission capable, and available), projected wireless network extension sites, and FM coverage (mission analysis side).

Signal Site Analysis

2-11. The G-6/S-6 should conduct a signal site analysis of the entire AO, if possible, the area of interest. (Signal site selection is explained later in the chapter.) This signal site analysis will provide flexibility later in the planning and execution process. For this analysis he should focus on providing area-type coverage, so should the mission change

and the operation is required in another area, he will already know where effective communications coverage can be obtained.

Note. Do not just focus on hilltops. Many times an effective location can be found in a valley or saddle that will provide a wireless network extension team better survivability than a hilltop that the enemy may also be trying to use as an observation post.

2-12. The G-6/S-6 must also know the effective planning distance for each available communications asset. Conducting an effective evaluation of the terrain and developing a visual understanding of how you will be able to support the mission is critical to planning process.

2-13. The G-6/S-6 must have a good understanding of the mission and terrain analysis products to help the commander visualize how the G-6/S-6 staff will support the mission. In many cases, a picture is worth a thousand words. The picture helps the commander understand what the staff is doing and why.

2-14. The G-6/S-6 will coordinate with the S-2 to determine the enemy threat to anticipated communications locations. If the S-2 has completed the enemy situation template, it can be used to ensure communications sites have not been placed on or near any enemy known or templated position.

2-15. As the G-6/S-6 determines the needs of the units, the potential number of wireless network extension sites/teams needed to cover the AO operations may become the criteria used later to determine which COA is most supportable.

2-16. A communications plan to support the intelligence, surveillance, and reconnaissance effort may be needed. The G-6/S-6 and intelligence, surveillance, and reconnaissance section will determine how best to support the intelligence, surveillance, and reconnaissance plan with communications. Many times the scouts/reconnaissance, surveillance, and target acquisition/long-rang surveillance conduct

Chapter 2

operations far from the current forward line of troops; therefore, they need long-range communications assets to support them.

2-17. Once the G-6/S-6 has identified all of the communications requirements, the staff must prepare and deliver the mission analysis brief to the commander. The commander needs to know the relevant information to develop a situational understanding and formulate detailed planning guidance. The commander and staff only need the G-6/S-6 information that could directly affect how the COA will be developed.

2-18. For example, if the high frequency range is a constraint because the operations area either does not have the use of high frequency ranges or there are a limited number of high frequency ranges available to the brigade, another means of communications for long-range communications will need to be identified. Additional information that should be briefed includes any attachments and detachments, equipment shortages and how the terrain affects communications. It is important for digital brigades to report on the range of the near-term digital radio based on the terrain.

WARNO (Number Two)

2-19. After the mission analysis brief, the staff disseminates WARNO (number two). It should include the following communications-specific elements—

- Time and place of the communications exercise.
- Information that was not available for WARNO number one.
- Visualization (graphic) products used for the mission analysis brief.
- Digital file(s) subordinate S-6s can modify and use for their mission analysis.

STEP THREE: COA DEVELOPMENT

2-20. During COA development, the staff can be developing two or three COAs based on the guidance given by the commander. COAs are

usually developed by the S-3 and/or the executive officer, not the commander. Many times the S-6 cannot cover down on the development of multiple plans because they are being developed simultaneously in different locations. In this case, the G-6/S-6 and communications chief can cover down on different COA development locations, or, if that is not possible, the G-6/S-6 should float between the locations to track all COAs.

2-21. It is at this point that effective terrain analysis, developed in mission analysis, become extremely important. The operation staff officer developing the COA may ask the G-6/S-6 if his plan can be supported by the communications plan the G-6/S-6 has been developing. The wrong answer from the G-6/S-6 here may result in a COA that is difficult or impossible to support during wargaming. A complete or nearly complete terrain analysis will allow the G-6/S-6 to answer this question with confidence.

COA Criteria

2-22. Each COA developed should meet the following criteria:

- **Complete.** It must complete the task in the mission statement.
- **Feasible.** The unit must have the capacity to accomplish the mission in the terms of available time, space, and resources.
- **Acceptable.** The tactical or operational advantage gained by executing the COA must justify the cost in resources, especially casualties.
- **Distinguishable.** Each COA must differ significantly from the others.
- **Suitable.** It must accomplish the mission and comply with the commander's guidance.

Note. While each maneuver COA must meet all five criteria, your communications plan need not. It may not need to be distinguishable; one plan may be able to support several COAs.

Decisive Points

2-23. The commander's staff should define the decisive point for each COA. The G-6/S-6 should focus on this point. The G-6/S-6 must absolutely be able to provide robust, reliable and redundant communications support.

S-6 Input to COA Development

2-24. The G-6/S-6 provides the following input during COA development—

- Use a terrain-based visualization program to refine proposed tactical operations center (TOC) and C2 node locations.
- Identify communications dead space.
- Conduct a risk assessment.
- Identify proposed TOC and C2 node locations and displacement triggers.
- Consider enemy locations.
- Plan for all phases of each COA to include the intelligence, surveillance, and reconnaissance fight.
- Apply the complete, feasible, acceptable, distinguishable, and suitable criteria to each COA.
- Consider primary, alternate, contingency, and emergency communications (PACE) for each COA. An emergency means of communications does not always have to be equipment; it may be a procedure, such as moving back to the last known effective communications point or linking up at a grid coordinate. The PACE concept has always been a valuable tool to ensure there is a back up communications plan in place in case the primary plan fails. An example of the PACE concept would be—
 - **Primary**—JNN.
 - **Alternate**—TACSAT.
 - **Contingency**—high frequency.
 - **Emergency**—SINCGARS.

STEP FOUR: COA ANALYSIS (WARGAMING)

2-25. COA analysis (wargaming) involves the following procedures—

- Assemble tools;
 - FM coverage.
 - Signal mission analysis chart (completed).
 - Map.
 - Signal wargaming matrix (with locations penciled in).
 - Evaluation criteria table.
 - Small signal/C2 icons (include main CP and TAC CP).
- Apply evaluation criteria.
- Identify critical events.
- Identify decision points.
- Recommend COA(s).
- Issue WARNO (number three).
- Prepare for OPORD brief.
- Prepare for rehearsals.

2-26. Wargaming is a disciplined process and is probably one of the most time consuming events other than conducting mission analysis. The G-6/S-6 will need to know what critical events the staff will wargame, the evaluation criteria for each COA, and what wargaming method will be used.

2-27. The commander or executive officer dictates which wargaming method the staff will use prior to the wargame. There are three wargaming methods:

- The **box method** is a detailed analysis of a critical area, such as an engagement area, a river crossing, or a landing zone. It is useful when planning operations in noncontiguous AO.

Chapter 2

- The **belt method** divides the AO into belts (areas) running the width of the AO. The belt method is most effective when terrain is divided into well-defined cross-compartments, during phased operations (such as river crossings, air assaults, or airborne operations), or when the enemy is deployed in clearly defined belts or echelons.
- The **avenue in depth method** focuses on one avenue of approach at a time, beginning with the decisive operation.

G-6/S-6 Wargaming

2-28. Prior to wargaming, the G-6/S-6 must have his tools ready to be effective. These tools include—

- FM footprint “slides.”
- COA evaluation criteria table.
- Signal wargaming tool matrix.
- Higher headquarters order.
- Map.
- Signal mission analysis chart.
- Signal modified table of organization and equipment analysis worksheet.
- Previously constructed icons or “stickies.”

2-29. The wargame follows an action-reaction-counteraction cycle. Actions are those events initiated by the side with initiative (normally the force on the offensive). Reactions are the other side’s actions in response. Counteractions are the first side’s responses to reactions. This sequence of action-reaction-counteraction is continued until the critical event is complete or until the commander determines that he must use another COA to accomplish the mission. The G-6/S-6 will move “stickies” during each turn and identify grid coordinates for key locations (refer to Figure 2-1 for an example of a signal wargaming matrix).

2-30. Throughout the wargame, the staff must evaluate each COA against some criteria that has been determined or approved by the

commander. The G-6/S-6 should also have some communications evaluation criteria he uses for each COA. This could be the number of wireless network extension teams needed to support each COA, the amount of security available to each wireless network extension team, or any other criteria the G-6/S-6 determines. Figure 2-2 can be used to help capture how the G-6/S-6 will evaluate each COA.

2-31. When the staff briefs the commander, only the criteria he set forth will be briefed; however, the G-6/S-6 may be asked which COA he can best support and why. Here is where the G-6/S-6 portion of the evaluation table can be used to clearly articulate why one is better and what evaluation criteria was used to reach a decision.

Communications Nodes

2-32. Prior to conducting the wargame, the G-6/S-6 should have already identified where he is going to place the wireless network extension sites/teams and any other communications nodes. This information is filled into the wargaming tool. The G-6/S-6 uses the tool when he briefs these locations at the wargame. The S-6 should talk in terms of where the signal node is located, its task and purpose, and its command relationship. The G-6/S-6 should also use triggers to jump the communications nodes forward.

Signal Wargaming Tool	Critical Event _____ OPORD _____	Reaction	Counteraction
Action			
TOC: _____ Task: _____ Trigger: _____	ALITOC: _____ Purpose: _____ Command Relationship: _____	<p>PACE, discussed in paragraph 2-24, should be incorporated providing flexibility for each action.</p>	
TOC: _____ Task: _____ Trigger: _____	ALITOC: _____ Purpose: _____ Command Relationship: _____		
TOC: _____ Task: _____ Trigger: _____	ALITOC: _____ Purpose: _____ Command Relationship: _____		
TOC: _____ Task: _____ Trigger: _____	ALITOC: _____ Purpose: _____ Command Relationship: _____		
TOC: _____ Task: _____ Trigger: _____	ALITOC: _____ Purpose: _____ Command Relationship: _____		
TOC: _____ Task: _____ Trigger: _____	ALITOC: _____ Purpose: _____ Command Relationship: _____		

Figure 2-1. Example of a signal wargaming matrix

Evaluation criteria established by staff/commander	Weight	Course of Action		
		COA 1	COA 2	COA 3
Comments for				
Comments Against				
S-6 Evaluation Criteria	Weight	Course of Action		
		COA 1	COA 2	COA 3
Comments For				
Comments Against				

Figure 2-2. COA evaluation criteria

Chapter 2

2-33. During the wargame, location tasks, purposes, triggers (synchronization), and command relationships may change. The wargaming tool can also be used to capture these changes. At the end of the wargame, the G-6/S-6 will use this chart to help him write his scheme of the signal support for the signal annex (refer to Annex D for an example of a signal annex).

STEP FIVE: COA COMPARISON

2-34. The G-6/S-6 will want to consider comparing C2 of his portion of each COA such as the number of wireless network extension systems needed to support each COA and the amount of security available to protect each wireless network extension team. (Refer to Figure 2-3 for a sample COA comparison-briefing slide.)

CRITERIA	WT	COURSE OF ACTION		
		1	2	3
SPEED	2	2 / 4	1 / 2	3 / 6
SIMPLICITY		2	1	3
MASS		3	1	2
VULNERABILITIES		1	2	1
TOTALWEIGHTED TOTAL		8 / 10	5 / 6	11 / 14

LESS IS BEST; COA 2

Figure 2-3. Sample COA comparison briefing slide

STEP SIX: COA APPROVAL (DECISION BRIEF)

2-35. During the COA approval, the G-6/S-6 needs to be prepared to discuss why he thinks a specific COA is more supportable than another. The G-6/S-6 should have a copy of the evaluation criteria he used to evaluate the various COAs. This chart covers not only specific evaluation criteria the staff used as a whole, but the evaluation criteria the G-6/S-6 used as well. These criteria could be anything from the amount of security available for each C2 node to the number of wireless network extension sites needed to support each COA. This chart becomes important because the staff's evaluation criteria often do not address issues with which the G-6/S-6 is concerned.

2-36. Many commanders go around the room and ask various staff officers if they agree with the COA recommended by the collective staff and, if not, why. The G-6/S-6 can use this chart to argue that the COA selected by the collective staff leaves the wireless network extension sites without security and makes them vulnerable.

Final Planning Guidance

2-37. After the commander selects the COA, he may issue some final planning guidance that may include a refined commander's intent, new commander's critical information requirement, priorities for warfighting functions to include communications guidance, orders preparation, and rehearsal and preparation guidance.

WARNO (Number Three)

2-38. WARNO (number three) should include any of the products that were used for the wargaming process that could be used by battalion S-6s in their planning. This should include main CP/TAC CP locations and the triggers to move them. These will become the basis for the scheme of signal support. Any FM footprint or other products developed should also be included as well as updated commander's critical information requirement and essential elements of friendly

Chapter 2

information, principle tasks assigned to subordinate units, preparation and rehearsal instructions, and the final time line for operations.

STEP SEVEN: ORDERS PRODUCTIONS CHECKLIST

2-39. The staff prepares the OPORD by turning the selected COA into a clear, concise concept of operation and required supporting information. The concept of operations for the approved COA becomes the concept of operations for the order. The commander reviews and approves orders before the staff reproduces and disseminates them.

2-40. The S-6 can use the following orders productions checklist—

- Publish base order paragraph 5 and the signal annex with all appendices.
- Continually check and verify that changes are included in Annex A, Task Organization.
- Publish the signal support overlays(s).
- Ensure all tasks to maneuver units are listed in both Annex H and the base order.
- Coordinate with the fire support officer and ensure no-fire areas are established over the C2 node sites.
- Publish initial and jump locations of all C2 nodes.
- Provide diagrams showing the scheme of signal support and FM coverage.
- Prepare for rehearsal(s): there are five types of rehearsals (FM 6-0):
 - Confirmation brief.
 - Back brief.
 - Battle drills/SOP rehearsal.
 - Combined arms rehearsal.
 - Support rehearsal.

2-41. The S-6 is responsible for writing paragraph 5 of the base order and ensuring task-organized units are listed in any additional annexes. Many times there is very little time in between COA approval, the OPORD brief, and producing the written OPORD. To be successful,

the S-6 needs to have a “shell” or template signal annex already developed that outlines all the necessary recurring items.

2-42. Appendices to the signal annex could include a bubble chart diagram for the FM nets, a listing of call signs, and the network diagram. Some critical information that some may consider information that should be included in an SOP could still be included in the OPORD; compromise procedures are a good example. This may be an SOP item, but many attached units will not have access to read the unit’s SOP.

2-43. The scheme of the signal support should be written by phase just like the base order. Each phase should start with the priority of communications for that phase followed by a space to allow for easy reference.

2-44. The G-6/S-6 should also produce an FM coverage overlay in maneuver control system or whatever management system the unit is using. Most of the time this overlay will not be displayed as part of the common operating picture system in the unit’s CP. However, if a communications node is lost during execution, the G-6/S-6 can call up the overlay and quickly brief the command and staff on how communications are affected across the AO. Commanders and staff can also use this as guide to understand where coverage can be provided.

OPORD Brief

2-45. The OPORD briefing will allow each staff section to provide its input while keeping the brief to approximately one hour. Information briefed should only pertain to the subordinate commanders receiving the order.

2-46. The G-6/S-6 should brief net priorities, task organizations, and TOC locations as well as C2 nodes with task purpose by phase. Use supporting terrain tools to show where the G-6/S-6 staff can and cannot provide communications support.

G-6/S-6 TROOP LEADING PROCEDURES AND THE MILITARY DECISION MAKING PROCESS

2-47. The final briefing of the OPORD is not the only responsibility of the G-6/S-6. Troop leading procedures extend the MDMP to small unit level. (Refer to 5-0 for more information on troop leading procedures.) Troop leading procedures provide leaders a framework for planning and preparing for operations. During the initial receipt of the OPORD or WARNO, the G-6/S-6 should brief the section sergeant/communications sergeant so subordinate Soldiers can start to prepare for their portion of the mission. During this time the communications section/platoon will ensure the following items are checked—

- Prescribed load list on hand.
- Basic load of batteries.
- Operational radios.
- Additional radios needed for contingency use.
- Deadlined communications equipment.
- C2 vehicles prior to deployment.
- Radio transmission operator's certification/maintenance training.
- Hardware and software that will be used to construct or troubleshoot while working on the information network (data cables, network interface card, software drivers).
- Updated signal operating instructions information (call signs, challenges, and passwords).
- Pre-combat inspection (load plans).
- Appropriate satellite access requests are submitted or DISA commercial SATCOM leases are operational.

2-48. The following are basic communications checks and balances that should be performed to ensure a successful mission once the OPORD is received—

- Verify the location of the field trains and administrative and logistics/combat trains for coverage of the administrative/logistical net.
- Coordinate signal support as required. Verify frequencies and COMSEC. Always verify that the TACSAT or additional wireless network extension assets will be available and briefed if needed.
- Coordinate with the medical officer and verify medical evacuation frequency and call signs.
- Coordinate location and times that the radio access unit/EPLRS filling stations are filling subscribers' terminal devices.
- Define time-sharing and procedures for critical nets, especially SATCOM-facsimile plan for liaison officers with required communications and communications electronics operational instructions (CEOI) to overcome problems with inter/intra service operations especially during short missions.
- Coordinate common-user nets and power requirements, which could simplify unnecessary redundancy during deployment.
- Ensure the S-3 has key communications events on the execution matrix, and net calls are done daily or tied to a specific event in the planning process.

SIGNAL SITE SELECTION

2-49. The following paragraphs explain how to conduct a signal site selection for a battalion/company or platoon size element.

2-50. All tactical situations are unique and depend on METT-TC. In every situation, the company must meet two basic requirements. First, the survivability of signal assets and personnel is vitally important to accomplish the company mission. Second, strict security programs and defense plans must be implemented at all levels of command.

Chapter 2

To accomplish these two requirements, the company must accomplish the following:

- Site commanders must form a defensive plan and escape routes for their site.
- The survival of the site depends on readiness. The site commander must ensure that each Soldier knows his part in the overall defense.
- All independent operations must include a risk assessment to reduce injury and damage to equipment.

Site Reconnaissance

2-51. The reconnaissance team should consider the following—

- Before occupation, leaders should perform a reconnaissance of the proposed area. For example, the reconnaissance team should consist of the company leader, the transmission supervisor (if applicable), node supervisor (if applicable), and a security team. The reconnaissance team participant will depend on the type of unit. The reconnaissance team will have FM communications at all times.
- When conducting a reconnaissance of a signal site, several considerations need to be made to ensure the selected site will meet all mission requirements. Key leaders from all sections that will occupy a site should participate in the reconnaissance.
- The reconnaissance team must ensure that the size of the site is adequate to accommodate all assemblages and that they can be tactically dispersed on the site.
- Ensure that the site can be easily secured. Take into consideration the size, the amount of personnel that will be available at any given time to defend the site, and the amount of entrances or avenues of approach leading to the site. Consider how well the site is concealed from major roads or other vantage points. This may involve traveling around the entire site from a distance to visualize what the enemy would see.

- Ensure that the site is close enough to the supported elements for them to connect to the signal assemblages. The farther away the shelters are from the subscribers, the harder it will be to troubleshoot.

Site Selection

2-52. The reconnaissance team should be considered the following for site selection—

- The site layout should be made including marking stakes to indicate where each signal assemblage should be parked. Proposed assemblage and antenna locations will be recorded in ten digit grids. Access roads should also be identified.
- A proposed site diagram should be made showing the site layout of all signal assemblages to include the route of all signal and power cables, and a plan for the use of a 30-meter mast. Planning cable routes will ensure sufficient separation between signal and power cables to prevent signal loss due to power hum on signal cables.
- The access road through the site should be planned and the buried cable points should be designated. This will allow new signal assemblages to be added to the site without disrupting communications.
- All designated ground guides and supervisory personnel will be briefed on the site layout and the designated entry routes into the site. The ground guides will direct the signal assemblages into their site positions by the designated routes and will provide organization and speedy movement onto the site.

Site Layout

2-53. The reconnaissance team should consider the following for the site layout—

- Separate all signal cables from power cables by at least 10 feet. The only place this is not possible is at the van signal entry panel. If signal and power cables must cross, cross them at right angles and separate with sandbags.

Chapter 2

- Site layout plans must give priority of positioning to antennas so they may have optimum locations.
- Pulse code modulation cables cannot pass within 200 feet of a high frequency station antenna or high frequency station coaxial cable.
- All ultra high frequency (UHF)/super high frequency (SHF) antennas will be installed high enough to clear terrain to the front, yet remain concealed by the trees as terrain allows.
- Each antenna will be located at the position that is best for its particular azimuth. Antennas will be placed at a minimum distance of twice the antenna height from power lines. Each antenna will be positioned so that if it falls, it cannot damage another antenna. Tents will not be placed within antenna fall radius.
- Antennas will be positioned to reduce the possibility of co-site interference.
- Each vehicle and generator set will have drip pans and chock blocks placed (front/rear) to prevent motion after positioning.
- Technical limitations of the equipment such as maximum length and number of cable runs.

SIGNAL SITE SECURITY

2-54. Signal sites must be able to defend themselves against sabotage, ground forces, and airborne/air assault forces with little or no outside help. They must also be prepared to survive enemy air, artillery, and chemical, biological, radiological, and nuclear attack.

2-55. There are several different types of signal sites. Some considerations must be made when planning a site defense, based on the chosen site. Current threat situational status is an important factor when planning and committing assets and personnel to defend a site. Use METT-TC and order priorities accordingly.

Remote Sites

2-56. Remote sites are small teams located in isolated positions, usually for relay or wireless network extension purposes. They cannot

defeat a large enemy force. Teams should try to remain concealed and report enemy activity to higher headquarters. The teams conduct risk assessments from the remote sites to determine the probability of mission success. Leaders must carefully track specific threats and move teams quickly when in danger.

Collocated Sites

2-57. Usually these teams, such as an extension node, deploy to support a unit CP. The team members are responsible for a portion of the perimeter defense. Careful coordination must be done with the collocating unit. One central authority should be responsible for all defense matters associated with the site.

Node Sites

2-58. Usually this platoon-sized signal element may or may not collocate with another unit. Based on the enemy threat level, the signal site commander must plan a site defense and coordinate with nearby units for mutual support.

PROFILING RADIO LINKS

2-59. Obtaining LOS between two stations is essential when forming a multichannel radio link. For most systems, the LOS planning range is about 40 kilometers (km) (28 miles), due to the earth's curvature. LOS analysis may be done by automated means using one of several different programs such as the System Planning, Engineering and Evaluation Device (hosted by the Marine Corps) or the Voice of America Coverage Analysis Program that was released by the US Department of Commerce. Refer to Figure 2-4 for an example of an LOS analysis study.

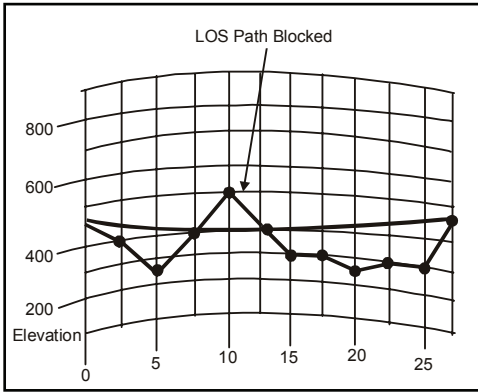

Figure 2-4. Sample LOS study

2-60. The materials needed to perform a manual radio LOS analysis are—

- Grid coordinates of both stations.
- Path profile paper, 4/3-earth radius (if possible).
- Map sheet containing both stations.
- Graphic Training Aid 5-2-12 protractor and coordinate scale.

2-61. Follow the steps below to perform a manual radio LOS analysis—

- **Step 1.** On the map sheet, place a dot at each proposed site location and circle it for ease of finding it later.
- **Step 2.** Draw a line from point A to point B and determine the distance between the two. If the distance is greater than 48 km (29.8 miles) and 40 km (24.8 miles) for mobile subscriber equipment (MSE), the points exceed maximum planning range and the transmissions may be too weak to receive. A relay may be needed; however, its use is undesirable and should be used as a last resort so that unnecessary assets are not tied up in one radio link.

- **Step 3.** Determine the elevation in meters of the originating and destination stations. Plot them the proper distance apart on the profile paper. (Remember to add the antenna height.)
- **Step 4.** Divide the distance between the stations into 1 km (.62 miles) increments.
- **Step 5.** Determine the highest elevation in meters at 1 km (.62 miles) increments. Plot these on the profile chart.
- **Step 6.** Connect the points to establish a graphic picture of the terrain along the path between the two stations.
- **Step 7.** Draw a straight line between the antenna stations. This line represents the multi-channel radio transmission path.

Note. If the transmission path does not clear the terrain, LOS is not possible. Another terminal site or a relay site should be chosen. Leaders at company, platoon, and team level should manually profile radio shots as soon as possible.

ADDITIONAL SIGNAL SUPPORT EQUIPMENT CHECKS DURING OPERATIONS

2-62. The following are basic checks and balances that should be performed once the unit is executing the mission.

2-63. Power, grounding, and power distribution are extremely important to signal planning. Approximately fifty percent of all communications outages are attributed to power failures. Key components to power planning are the selection of a power source, set-up of power generators, grounding of power sources and electrical components, and distribution and extension of power.

Chapter 2

Note. Power (symbol P) is defined by units called watts (W). Current (symbol I) is defined by units called an ampere (amp or A). Voltage or the potential difference (symbol E) is defined by units called volts.

Power = (Current) x (voltage) or $P = IE$ or $P = I$ (voltage)

GENERATORS, CIRCUIT BREAKERS, AND POWER SOURCES

2-64. Signal Soldiers are often signed for or responsible for unit generators. The right generator, circuit breaker, and power source will ensure signal equipment functions properly. Before a power source is selected, separate signal equipment from air conditioners, refrigerators, microwaves, heaters, coffee pots, etc. Air conditioners have compressors, and for most models, the compressor only engages periodically. Each time the compressor engages, the power draw increases, creating fluctuation in the current available. Current fluctuations cause electronic devices to react abnormally and failure is more likely to occur.

2-65. Circuit breakers need to be rated for the circuit requirements. For example, a 20 amp circuit breaker on a 110 volt circuit provides $P = (110)(20) W = 2200 W$ or 2.2 kilowatts (Kw).

2-66. Generators must be set up properly and be matched to the task. Generators normally operate with one, two, or three phases, and should be loaded to 80 percent of capacity when possible. Loads should be distributed to all phases of the generator.

2-67. Phases of the generator divide the available power rating by the number of phases. For example, a single-phase 10 Kw generator provides $P = IV$, $10 Kw = (110)(I)$ or $I = 10 Kw/110 \text{ volts} = 90 \text{ amps}$. A three phase 15 Kw generator provides 5 Kw on each circuit or $5 Kw/110 \text{ volts} = 45 \text{ amps}$. Therefore, if a 50-amp circuit is required, a single-phase 10 Kw generator is better than a three phase 15 Kw generator. Bigger is not always better when taking all of these factors into consideration.

2-68. Power generators require level ground and proper grounding. Power sources are especially susceptible to faults when electrical grounds do not meet to standards. Generators typically have 9-foot copper ground rods with copper grounding cables that should be used at all times. Ensure they are checked (less than 25 ohms of resistance) after installation. Use ground test meters every time to ensure proper ground before operation. Use salt and water, add ground rods and link them together with copper cable until the requirement is met; less resistance is better. Never ground a power source together with a signal entry panel or any signal equipment. Power sources and power feeders should always remain separate.

2-69. Power generators play an important role for signal leaders. The following steps are equally important, whether using commercial or tactical generators. Ensure the following steps are being preformed to keep generators working properly during operations—

- Paralleling generators and using switch boxes can be essential to a power plan for communications equipment. Generators must be cabled properly, and the switch box must be rated to perform the job. Even in the best situation, a power spike or failure may occur if the system is not set up right.
- Ensure power generators are in good working order and track hours operated by using the hour meter or by keeping a logbook, and perform preventative checks and services before, during, and after operations.
- Use clean, uncontaminated fuel.
- Replace air and oil filters regularly and more often in austere environments. Most generators must be off line to change filters. Sandy environments can cause air filters to clog quicker than normal so replace or clean them more often when necessary.
- Generators must be kept as cool as possible. Sun loading (sun shining directly on a generator) can cause overheating. Shading a generator with sunshades or camouflage can keep the temperature within the normal operating range even if the ambient temperature is high.

Chapter 2

- During operations, it is important to watch the loading of generators. Usage can also cause the load to become unbalanced.
- Ensure all Soldiers know how to use a multimeter on all assigned equipment. They are essential for signal equipment and can make the difference between a piece of equipment staying in good condition or always having to be repaired. Another useful tool is a plug-in polarity checker (which can be found at most electrical shops). The polarity checker has light emitting diode readouts that provide information about the source of power.
- Ensure that all operators are proficient in cutover emergency procedures.

2-70. It is important for signal leaders to know what power is available at all plug-in points being used. Most equipment comes with a power cord and the cord is rated to provide the needed electricity to the electronic components from the origination source.

2-71. If the length of the provided power cable is being extended by using extension cords or other cables, measure the power available at the source of the last plug, or calculate the power loss for the cable and ensure the original source can provide what is needed over the distance of the extension. The gauge of the cable or the loss rating will need to be known.

2-72. An uninterruptible power supply (UPS) at the end of an extension cord cannot recharge if it is not provided enough power. If the UPS is getting just enough power to provide power to the components it services, when back-up power is needed the UPS will fail. Soldiers must measure the power into the UPS and ensure it has the capacity to provide failsafe power to the components it is responsible for protecting. In the wrong configuration, the UPS may inhibit the components from working properly by taking power from the source. Even a fully charged UPS may steal power from the circuit over time.

Chapter 3

The Network

The network is an essential asset that enables the Army to rapidly transform and execute full spectrum joint operations. The network enables leaders with minimal forward presence to C2 maneuver formations, sustain the force, and achieve broad political-military objectives across the full spectrum of operations. The network touches every entity, including individual Soldiers. It is a critical weapon in the fight and must be robust, flexible, and adaptive to the commander's needs. This chapter provides an overview of the GIG, LWN, network C2, and current and future networks.

GLOBAL INFORMATION GRID

3-1. The Department of Defense (DOD) Directive 8100.1 defines the GIG and its assets as globally interconnected, end-to-end set of information capabilities, associated processes, and personnel for collecting, processing, storing, disseminating, and managing information on demand to Soldiers, policy makers, and support personnel. The GIG includes all owned and leased communications and computing systems and services, software (including applications), data security services, and other associated services necessary to achieve information superiority. It also includes National Security Systems as defined in Section 5142 of the Clinger-Cohen Act of 1996.

Chapter 3

3-2. The GIG supports all DOD, national security, and related intelligence community missions and functions (strategic, operational, tactical, and business) in war and in peace. The GIG provides capabilities from all operating locations (bases, posts, camps, stations, facilities, mobile platforms, and deployed sites). The GIG also provides interfaces to multinational and non-DOD users and systems.

3-3. The overarching objective of the GIG vision is to provide the President and Secretary of Defense, DOD personnel, intelligence personnel, businesses, policy makers, and non-DOD users with information, decision superiority, and full-spectrum dominance.

3-4. Achieving the GIG vision requires substantial augmentation of today's information sharing technology features and new technology capabilities. The preponderance of GIG functionality will be realized through leveraging commercial technologies and standards (augmented as necessary) to meet unique DOD mission critical needs. These needs pertain to availability, integrity, confidentiality, access control, and non-repudiation.

3-5. The signal planner relies on the NETOPS functions of management of the network, information dissemination, and network defense to ensure that commanders at each echelon retain the flexibility to employ LWN capabilities in the most decentralized fashion to meet their operational needs; while also ensuring the LWN meets the interoperability standards necessary to allow full integration in to the GIG.

ECHELONED AND INTERDEPENDENT NETWORKS

3-6. A joint-focused network is based on a mix of military and commercial systems that capitalize on new and emerging technologies to provide enhanced capabilities to commanders and staff at all echelons.

3-7. The network must provide—

- Seamless end-to-end capabilities for:
 - National security, DOD, and intelligence community requirements from peacetime business support through all levels of conflict.
 - Strategic, tactical, post, camp, and station level users.
- Information capabilities for:
 - Joint high capacity netted operations.
 - Linking state-of-the-art weapons and intelligence, surveillance, and reconnaissance systems.
 - US government interagency information sharing capability.
 - Strategic, tactical, and functional applications.
 - “Plug-and-play” interoperability and connectivity between US and multinational users.
 - Defense in depth against all threats.

MULTINATIONAL NETWORKS

3-8. Multinational, interagency, and commercial networks exist throughout the tactical environment. They are an integral component of the network and enable Soldiers to use the network as a multinational and joint force network. The requirement and ability to exchange information between multinational and joint forces are critical to a successful leverage and use of all information available to today’s Soldier.

LANDWARNET

3-9. LWN is the Army’s portion of the GIG. LWN encompasses all Army information management systems and information systems that collect, process, store, display, disseminate, and protect information

Chapter 3

worldwide. It enables execution of Army C2 processes and supports operations through wide dissemination of relevant information. LWN facilitates rapidly converting relevant information into decisions and actions. It allows commanders to exercise C2 from anywhere in their AO.

3-10. LWN consists of all Army networks, from sustaining military bases to forward deployed forces. It includes all Army owned, leased, and leveraged DOD communications as well as computing systems and services, applications, and data security services. LWN is the combination of infostructure and services from across the Army and consists of the corps, division, and BCTs/brigade's supporting deployed forces. LWN also includes the National Guard Net and the Army Reserve Net.

3-11. Tactical networks rely on the LWN for C2 and sustainment support. They leverage internal, strategic, and national capabilities to orchestrate the theater network battle. The corps, division, and BCT will deploy into theater from multiple force projection platforms. This complex environment demands full connectivity, complete synchronization, and consistent worldwide standards to allow immediate access to the fight. Corps, division, and BCTs will dynamically maneuver forces and employ network capabilities within the enterprise. The integration of network capabilities across all echelons (BCT to BCT, BCT to division, division to corps, etc.) will require total synchronization across all NETOPS disciplines.

Note. NETOPS is addressed in detail in other doctrinal publications that may be accessed on the doctrine AKO portal at <http://gordon.army.mil/doctrine>. These publications include tactics, techniques, and procedures, organization details, operational imperatives, responsibilities, and detailed policies for Army NETOPS affecting the LWN and joint communications systems. The portal requires a common access card to access.

NETWORK COMMAND AND CONTROL

3-12. The senior mission commander at each echelon commands and controls the network. To ensure that a seamless and autonomous network is achieved, the senior mission commander delegates authority to the G-6 for the following—

- Control and configure the network.
- Move signal personnel and equipment around the battlefield.
- Modify network configuration specifications on the battlefield to support both current and future operations.

TELECOMMUNICATIONS SERVICE ORDER

3-13. The G-3 executes control through the OPORD process, and the G-6 executes control through the TSO process. For current operations, the G-6 executes network reconfigurations based on the TSO process and as specified by the commander in the OPORD. These changes include frequency modification, router configurations, or equipment settings. When reconfiguration involves the movement of personnel and equipment within the current operation, the G-6 coordinates the adjustment with the G-3, and the appropriate FRAGO is issued by the G-3 in support of the reconfiguration.

3-14. The TSO carries the same weight as an appropriate FRAGO for the configuration of the network. This process flows from the CCDR J-6 through the JTF operational chain of command structure to facilitate the establishment and health of the enterprise network and theater network.

MILITARY DECISION MAKING PROCESS

3-15. The G-6/S-6 officer participates in the MDMP and identifies the correct placement of network equipment and personnel on the battlefield in support of the mission. The information is then vetted, through COA development, and published in the unit OPORD and requisite signal annex. (Refer to Chapter 2 for a more in-depth explanation of the role the signal planner plays in the MDMP process.)

NETWORK OPERATIONS

3-16. NETOPS is the operational construct consisting of the essential tasks, SA, and C2 that the Commander, United States Army Strategic Command will use to operate and defend the GIG. The Army uses the NETOPS construct to operate, manage, and defend its portion of the GIG, the LWN. NETOPS provides units the ability to harness the power of the LWN and bring this power to the battlefield where it is needed most, thus increasing the lethality of Army tactical units.

3-17. The objective of NETOPS is to enable Army signal commanders and G-6/S-6s to provide communications system operations support to users conducting the Army's operational mission. NETOPS enables the allocation of network, information system, security, and information dissemination resources that directly support operational forces. NETOPS provides users with end-to-end connection and visibility of strategic, operational, and theater and tactical network management, IA, and information dissemination management resources.

Note. FM 3-0, Chapter 7 covers information superiority consisting of: intelligence, surveillance and reconnaissance, information operations, knowledge management, and information management. Information protection is an Army information task that contributes to information superiority and usually falls directly under the responsibility of the G-6/S-6.

INFORMATION PROTECTION

3-18. Information protection is a key component of information superiority and is the active or passive measures to protect and defend friendly information and information systems to ensure friendly access to timely, accurate, and relevant information while denying adversaries the opportunity to exploit friendly information and information systems for their own purposes. Information protection comprises IA, CND, and electronic protect capabilities (FM 3-0).

INFORMATION ASSURANCE

3-19. IA provides for the restoration of information systems by incorporating protection, detection, and reaction capabilities and consists of measures that protect and defend information and information systems by ensuring their availability, integrity, authentication, confidentiality, and non-repudiation—

- Availability is the timely and reliable access to data and services by authorized users.
- Integrity is the protection from unauthorized change, including destruction.
- Authentication is the certainty of user or receiver identification and authorization to receive specific categories of information.
- Confidentiality is the protection from unauthorized disclosure.
- Non-repudiation is proof of message receipt and sender identification, so neither can deny having processed the data.

COMPUTER NETWORK DEFENSE

3-20. CND consists of measures designed to protect and defend information, computers and networks from disruption, denial, degradation or destruction. It includes all measures to detect unauthorized network activity and computer network attack and to defend computers and networks against it. These measures include access controls, malicious computer code and program detection, and intrusion detection tools.

ELECTRONIC PROTECTION

3-21. Electronic protection is that division of electronic warfare involving actions taken to protect personnel, facilities, and equipment from any effects of friendly or enemy use of the electromagnetic spectrum that degrade, neutralize, or destroy friendly combat capability. Friendly forces use emission control and other anti-jamming measures to perform electronic protection. See FM 6-02.70 for further information on electronic protection.

NETWORK SERVICE CENTER

3-22. The network service center concept addresses the Soldier requirement for ubiquitous, standardized, and modular service support across the globe. The network service center is a virtual collection of standardized capabilities realized via several disparate facilities and organizations. While initial network service center capabilities will be Army-focused, the objective network service center is a joint capability and would provide standard services to any theater operational or strategic or tactical unit as defined by joint guidance.

3-23. The network service center is a capability consisting of a combination of the following—

- Network transport, comprised of regional hub nodes (fixed regional hub node [FRHN], mobile regional hub node [MRHN], and THN) and their associated capabilities.
- Information services, including area processing centers, knowledge centers, and GIG enterprise services.
- NETOPS functions performed at each echelon.

3-24. FRHNs associated with network service centers will be positioned to provide near global coverage with the MRHNs and THNs available to service units deployed outside the coverage of FRHNs. FRHNs enable the corps, division, and brigade to deploy rapidly without requiring the advanced deployment of the organic division hub node. The network service center is a regional asset that supports geographic CCDRs and is operated by theater signal brigades.

3-25. The network service center will provide a fixed platform in sanctuary at which user servers and applications can be hosted, giving immediate access to required services and servers located at the FRHN or area processing center. The network service center can be pre-loaded with Army applications, standard baseline operating systems, patches, and security configurations to allow a seamless transition for the deployed user.

3-26. Corps and expeditionary signal battalions (ESBs) do not have organic hub nodes and will draw their support primarily from an FRHN

or THN. FRHNs also augment division THNs when the operational requirements exceed its capacity.

G-6/S-6 NETWORK OPERATIONS

3-27. The responsibilities of the G-6/S-6 at each echelon, discussed earlier, lays out the specific roles of each cell within the G-6/S-6 section. This section focuses on the NETOPS functions of the G-6/S-6.

3-28. NETOPS control is the authority granted to a senior signal officer and his staff from their immediate operational commander in compliance with joint, Army, and theater NETOPS policy and direction. This ensures the day-to-day compliance of their network with their associated LWN and GIG requirements. In addition, the fast moving nature of NETOPS, which is inherently a 24-hour/7-day operation, requires quick decisions and adjustments that exceed the responsiveness of the traditional orders process.

3-29. The Army identifies technical matters such as network operations and assigns responsibilities for them to an appropriate organization. These organizations use technical channels established by regulation policy or directive (FM 3-0).

3-30. The senior ARFOR mission commander commands and controls the tactical Army network in compliance with joint, Army, and theater NETOPS policy and direction. To ensure that a seamless and autonomous network is achieved, the mission commander delegates the authority to control and configure the network to the G/S-6. The G/S-6 executes this control through the TSO process.

3-31. The TSO process and technical channels are used for coordinating the configuration of the network. This process flows from the geographic combatant commander (GCC) J-6 through the JTF, combined JFLCC, ARFOR, corps, division, BCT, and the battalion J-6, G-6, and S-6 structure respectively to facilitate the establishment and health of the enterprise network and theater network.

Chapter 3

3-32. Through technical channels coordination and the TSO process, the signal officer and staff execute the commander's directives to maintain and secure their network. This process involves policy, guidance, and directives issued to subordinate signal organizations along the NETOPS channels. The TSO does not allow the commander's signal staff to move equipment or personnel but it does allow them to coordinate configuration management of network devices within their AO. If there is a need to move equipment or personnel in order to meet network requirements, the signal staff coordinates with their respective G-3 or S-3 and issue a FRAGO to the existing signal annex of the OPORDs for movement.

3-33. It is important to remember the TSO is a current operations process. The TSO is designed to give the commander, through his signal staff, a means to adjust and modify the existing network plan to meet unexpected circumstances that can range from outright network attacks to system failures and service interruptions. Any future NETOPS control issues must be planned and executed through the orders process (MDMP) performed by the chain of command.

3-34. All signal elements at each echelon must coordinate with the superior G-6/S-6 element during the engineering, installation, operation, maintenance, management and defense of the information network. The maneuver battalion coordinates with the BCT S-6 who in turn coordinates with the division G-6 and so on to provide a holistic network with each echelon controlling their information systems based on guidance and procedures from their next higher echelon. Each echelon G-6/S-6 has overall responsibility for establishing information network and provides the operational and technical support to all units assigned or attached operating in the AO.

NETOPS MISSION PLANNING

3-35. NETOPS mission planning is the collection of current and future user requirements, requirements validation and prioritization, mission alignment to the commander's intent, the allocation of technical and organizational resources, and the publication of

OPORDs. Major NETOPS mission planning is normally performed during the first phase of the operation. Smaller scale mission planning is performed in all phases of operations as dictated by mission requirements.

3-36. All organizations are involved in the NETOPS mission planning process. As each echelon performs mission planning, guidance is given to subordinate echelons. This guidance is then used to create or refine NETOPS mission planning at the lower echelon. Mission planning is a continual process that is performed by the organization's S-6/G-6 staff.

3-37. For the BCT and below, NETOPS mission planning is performed by the BCT S-6. The BCT provides mission planning support to subordinate maneuver battalions.

3-38. The corps and division G-6 performs NETOPS mission planning in support of the corps and division. The corps and division provide mission planning guidance to assigned BCTs and support brigades as well as coordinating mission planning efforts between its subordinate BCTs and support brigades

CURRENT AND FUTURE NETWORKS

3-39. The network requires corresponding investment and improvements, from home station to deployed forces. Linking deployed commanders to strategic and national resources remains critical. The standardized tactical entry point (STEP), teleport, FRHN, or THN supports this capability by allowing worldwide, real-time collaborative planning and execution. A subset of STEP sites are being upgraded to teleports, enabling access to both military and commercial satellites.

3-40. As the Army transforms to a lighter, more mobile, modular, and strategically responsive organization, the network is also transforming to a fully enabled robust network with the creation of area processing centers to enable an always-on, secure, global, plug-n-play capability for expeditionary forces.

Chapter 3

3-41. Area processing centers are Army enterprise infostructure centers located on DOD facilities at which functional and common services applications are run, associated information is stored and replicated, and that information is consistently NETOPS managed. Area processing centers interface to Army installation networks through an Army network-level secure Virtual Private Network service provisioned within the DOD GIG terminated at an Army Enterprise-managed LWN point of presence and to Army deployed forces through Warfighter Information Network-Tactical (WIN-T) Increment 1 hub nodes, DOD standard tactical entry points, and DOD teleports.

3-42. Area processing centers are operated, managed, and defended by NETCOM/9th Signal Command (Army) [SC(A)], while still permitting warfighter and functional application owners to securely and remotely manage their processing assets and data within the centers.

3-43. The network enables leaders of the joint and expeditionary force to C2 maneuver formations while sustaining the force with minimal forward presence. The network reaches every entity, to include the individual Soldier, and allows leaders to achieve broad political-military objectives across the full spectrum of operations.

3-44. To achieve these capabilities, the Army is currently fielding the WIN-T Increment 1, an interim network transport solution as part of the WIN-T program. The interim capabilities include a SATCOM based network infrastructure that enables commanders to C2 Army, joint, and multinational forces. The future Joint Tactical Radio System will extend the network battalion and below.

3-45. The components of Joint Tactical Radio System include airborne, maritime, fixed station, ground mobile radio, and handheld, man-pack and small form fit. The Joint Tactical Radio System is a software-based networking radio that will deliver networks to the mounted, dismounted, and un-mounted joint force. Pre-engineering design model ground mobile radios are currently available in the Experimental BCT Future Combat System.

Chapter 4

Theater Operations

Theater operation assets are those signal elements that fall under the signal command of any given theater, as well as those entities that fall under NETCOM that support signal operations for an ASCC AO and above. Those elements include Soldiers, systems, equipment, materiel, applications, and facilities apportioned within a theater to install, operate, maintain, and defend LWN capabilities, which provide network enabled capability and facilitate information superiority at strategic, operational, and tactical levels. This chapter discusses the missions, functions, and characteristics of theater operations as they relate to changes fueling the Army's move to transformation and modularity.

LEVERAGING THEATER OPERATION ASSETS

4-1. Theater operation assets to do the “heavy lifting” in extending GIG services to the JFC, ASCC commander, and Army elements operating in theater operational echelons and above. Most often, this means installing and operating large-scale, non-mobile network infrastructures, tactical gateways, heavy network systems, nodes and

hubs necessary for increased bandwidth, range extension, and theater reachback. Theater operations often provide large-scale connections between tactical networks and the GIG. Theater operations provide a pooled network provisioning capability in general support of tactical forces without organic network support. An ESB's mission is significant in not only installing, operating, maintaining, and defending the LWN at higher levels of command, but also in providing network support to ASCC elements operating at the tactical corps/division levels.

4-2. The primary design of theater operations is to provide the resources and personnel necessary to meet flexible conditions sometimes in austere environments. They meet the requirements for large-scale network and information services for major command posts, installations, facilities, base clusters, and enclaves. Most notably, they provide networks and services supporting large user populations located at—

- JTF, ARFOR, JFLCC, or Theater Army HQ.
- Theater base support and intermediate staging bases.
- Seaports of debarkation (SPODs) and aerial ports of debarkation (APODs).
- Tactical assembly areas.
- Theater and logistics support centers.
- Logistics operations centers and supporting temporary installations.

PROVIDING “OTHER” SERVICE SUPPORT

4-3. Theater operations also perform a variety of missions to meet specialized requirements. This extends to supporting other services such as non-governmental organizations and the Department of Homeland Security (DHS).

SUPPORT TO NAVFOR, MARFOR OR AFFOR COMPONENT JTF

4-4. A JTF performing missions having specific, limited objectives or missions of short duration normally dissolves when its purpose is complete. These missions very likely generate very specialized network requirements that cannot be met with organic resources. The JTF must often rely on a signal command to augment those of its service component in order to tie joint network requirements effectively to the GIG and fully integrate service communications links to ARFOR, AFFOR, MARFOR, JSOTF, and NAVFOR. Vital to the JTF mission is the capability of the signal command to provide an in-range extension of reachback services. Because JTF and combined headquarters are not fixed organizations, network support must be scaled to the requirement based on METT-TC. One aspect of meeting modularity requirements is the ability to “plug and play” signal assets to meet unique or tailored needs.

SUPPORT TO THE DHS

4-5. The mission of the DHS is to prevent terrorist attacks within the United States, reduce America’s vulnerability to terrorism, and to minimize damage, mitigate effects, and recover from attacks that do occur. To accomplish this mission, DHS has the authority to mobilize resources of the federal government to include continental United States (CONUS) based signal assets. The foremost role of these assets is to provide LWN capability in support of DHS crisis situations and the interface of Army information systems with government agency information systems. Crisis response operations involve Army tactical elements in a variety of roles. C2 of those elements require flexible, secure communications system networks that are independent of civilian and government networks. Army networked communications provide responders with communications means that are free from the potential degradation posed by threat activity or overuse. They also enable interface with other branches of service to provide joint force capability should the situation require it.

SUPPORT TO SPECIAL OPERATIONS FORCES

4-6. Special operations forces (SOF) comprise specific missions that may find signal commands augmenting organic, dedicated SOF signal forces tasked to provide C2 networks and communications systems to a joint special operations task force, combined unconventional warfare task force or coalition SOF task force. On occasion, SOF must operate in conventional environments or require theater augmentation to meet network requirements. Base operational support to SOF units often calls on signal commands. Particular to this case are Civil Affairs, psychological operations, and SOF engaged in specialized theater missions such as weapons of mass destruction counter proliferation, coalition support, security assistance, foreign internal defense, as well as network links into theater LWN.

SECTION I – MAJOR COMMANDS

NETCOM/9TH SC(A)

4-7. NETCOM/9th SC(A), as a direct reporting unit to Headquarters, Department of the Army (HQDA) chief information officer (CIO)/G-6, is the predominant signal force and network service provider related to the Army and Theater LWN enterprise and the GIG. NETCOM/9th SC(A) has authority to implement and enforce enterprise policy and provides authoritative guidance concerning the techniques, procedures, standards, configurations, designs, devices and systems to accomplish specific functional tasks and missions. NETCOM/9th SC(A) has full enterprise level responsibility for all global Army networks and information systems that comprise LWN. NETCOM/9th SC(A) CONUS trained and organized tactical forces are OPCON to US Army Forces Command (FORSCOM), specifically for supporting specific national command authority objectives. NETCOM/9th SC(A) delivers IT and common user services and exercises administrative control (ADCON) of service assigned and attached forces to support the GCC and the ASCC commanders.

4-8. Headquarters, NETCOM/9th SC(A) is comprised of a standard general officer level staff (G-1 through assistant chief of staff, logistics (G-4) and assistant chief of staff, resource management (G-8) located at Fort Huachuca, Arizona, and an liaison officer (LNO) staff and leadership presence in the National Capital Region working directly with Army CIO/G-6 and other DOD service staffs (refer to Figure 4-1). The headquarters can deploy C2 or technical elements to a theater of operations to support CCDR requirements directly or to augment subordinate units.

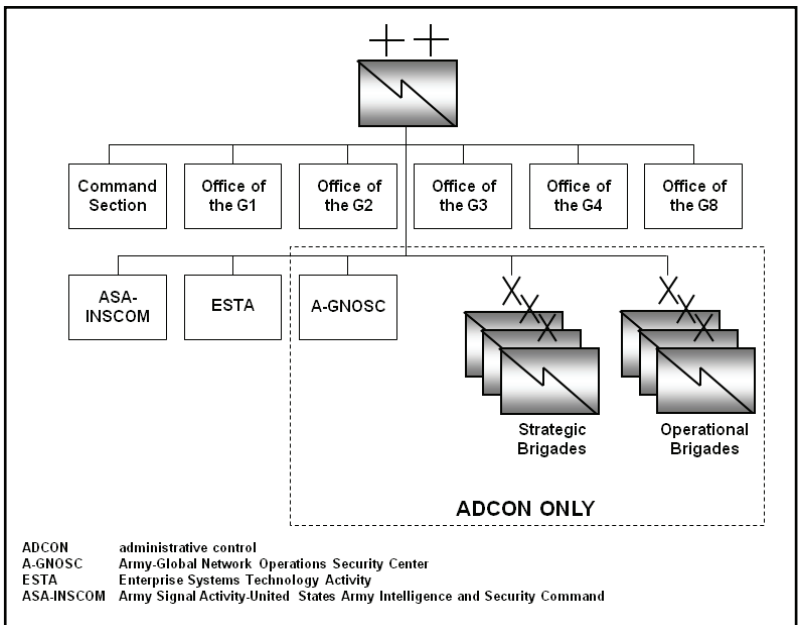

Figure 4-1. NETCOM/9th SC(A) Organization

Chapter 4

4-9. NETCOM/9TH SC(A) is the single Army authority to operate, control, and defend the Army's infostructure at the enterprise level. It is a global enterprise framework including theater signal commands, brigades, NETOPS and security centers and regional chief information officers (RCIOs), with the senior Theater-level signal commander serving as the ASCC G-6. It has the authority to implement and enforce enterprise policy and provides authoritative direction concerning the techniques, procedures, standards, configurations, designs, devices and systems to accomplish specific functional tasks and missions. It exercises authoritative enterprise NETOPS technical direction over all organizations that operate, connect to or maintain the LWN Army's portion of the GIG. NETCOM/9th SC(A), in supporting the CIO/G-6 and serving as a global and theater force provider has the responsibility to—

- Assign operational tasks affecting theater LWN.
- Designate network related objectives to support combatant command requirements.
- Resource operational requirements.
- Provide staff actions in direct support of mobilization requirements.
- Provide deployment or deployment sustainment operations.
- Provide integration oversight for the Active Army and Army Reserve (USAR).
- Provide oversight of training and exercises.
- Provide support to the Homeland Security Operations Center and reachback operations.

4-10. NETCOM also performs the following tasks and functions:

- Executes oversight for centralized configuration and compliance for theater LWN. This requires monitoring and oversight of configuration changes of Army tactical and strategic voice and data infrastructures to ensure interoperability with joint directives.
- Manages the Army Military Affiliate Radio System program.
- Provides engineering support to the ASCC G-6 or signal command as required or when requested.

- Engineers, installs, operate, and maintain data networks in support of JTF, Army, and nongovernmental agencies as required.
- Serves as the proponent for quality assessment, quality control, and assistance control for communications infrastructure, systems, networks, and sub-networks by means of deployed assessment teams.

NETCOM MAJOR SUBORDINATE ELEMENTS

4-11. In addition to its command relationship with CONUS and outside continental United States (OCONUS) signal commands, NETCOM also has direct relationship over several subordinate elements that are vital to the LWN and network enabled capabilities: Enterprise Systems Technology Activity (ESTA), the Army-Global Network Operations and Security Center (A-GNOSC), and the Army Signal Activity-United States Army Intelligence and Security Command (ASA-INSCOM).

Enterprise Systems Technology Activity

4-12. ESTA is NETCOM's subordinate and is responsible for engineering, installing, operating, maintaining, and defending enterprise networks throughout the LWN. ESTA develops, implements, and enforces enterprise systems management (ESM) processes and activities required to operate and manage the LWN and Army interface with the GIG. In addition, ESTA—

- Serves the Army CIO/G-6.
- Coordinates external requirements with the HQDA staff and major Army command CIOs.
- Establishes ESM and IA policies and procedures and executes necessary actions to ensure common user services within a secure NETOPS framework across the LWN enterprise.
- Provides operational policy and functional staff oversight for ESM operations to CONUS installation DOIMs and RCIOs.
- Assesses, develops, staffs, and manages ESM functional proponent requirements and service level agreements for the LWN.

Chapter 4

- Conducts testing, evaluation, and architectural review of operational architectures to ensure that new systems facilitate technological compliance. Ensures all capabilities fielded within the LWN conform to established standards, practices, and procedures.
- Provides technical expertise to execute long-haul and base communications programs.
- Provides oversight of all Army activities related to the allocation, allotment, and assignment of RF spectrum.

Army Global Network Operations and Security Center

4-13. A-GNOSC is another essential sub-element of NETCOM. Its mission is to develop and disseminate LWN situational understanding by collecting and maintaining near real-time status information on vital LWN resources, networks, information systems, and intra-theater gateways (STEP and teleport). Its primary mission focus centers on LWN operational compliance, management, and defense. The A-GNOSC is integrated with the 1st Information Operations Command (Land) and the Army Computer Emergency Response Team (ACERT) to create a consolidated NETOPS center called A-GNOSC/ACERT TOC. Each TNOSC is integrated with a Regional Computer Emergency Response Team (RCERT).

Compliance

4-14. The A-GNOSC has the authority to ensure implementation of and compliance with approved DOD, joint, and Army NETOPS policies and procedures. The A-GNOSC also maintains liaison with the Army operations center and the 1st Information Operations Command. The A-GNOSC will ensure compliance with network system standards and operational procedures before any IT resource, network, system, or application is connected to the LWN. A-GNOSC will also participate in reviews, tests, evaluations, and forums affecting information systems development, architectures, applications, and interfaces.

Management

4-15. The A-GNOSC interfaces with the Joint Task Force-Global Network Operations (JTF-GNO) Global Network Operations Center, all Army TNOSCs, and functional and other service NOSCs in order to provide worldwide operational and technical support across strategic, operational, and tactical levels. It serves to resolve problems affecting network services and operations in two or more theaters and oversees domain name services (DNS) and Internet protocol (IP) services provisioning and management for Army Forces.

Defense

4-16. Operating in conjunction with the ACERT, the A-GNOSC plays a major role in a comprehensive and global network defense for the LWN and tactical networks, including monitoring compliance with issued IA vulnerability alerts and directing Army-wide actions.

Army Signal Activity-United States Army Intelligence and Security Command

4-17. ASA-INSCOM falls under the command authority of NETCOM/9th SC(A) and under OPCON of the INSCOM. The ASA-INSCOM commander serves dual roles and is also the INSCOM G-6. ASA-INSCOM's mission is to provide planning, programming, budgeting, engineering, installation, and operational management of secure and non-secure telecommunications to the National Security Agency, HQDA, INSCOM, and NETCOM/9th SC(A).

SECTION II – STRATEGIC AND FIXED STATION ELEMENTS

Strategic and Fixed Station

The terms *strategic* and *fixed station* describe organizations that do not typically deploy from their home stations and include organizations that provide intra- and/or inter-theater communications. These organizations typically support both power projection and C2 requirements spanning from the warfighter through the Secretary of Defense to the President of the United States. They form the “backbone” of the LWN and are the focal point for installation support and theater extension. Because of the fluid nature of the contemporary operational environment, some theater and strategic organizations find themselves supporting the operational level of war. For this reason, efforts have been made to re-designate all strategic and fixed station organizations as “operational base” signal forces.

Note. The strategic signal organizational structure is in the process of changing. The focus is shifting the current structure from a scenario-based to a capability-based design. The following outlines the new structure and its capabilities.

STRATEGIC SIGNAL BRIGADES

4-18. The mission of a strategic signal brigade is to provide operational base and sustaining signal support (communications, automation, and network management) to maintain the warfighter in a geographic area of responsibility (AOR) and to enable power projection platforms required for force projection. These units provide the following:

- C2, operations, logistics, and administrative support for all assigned communications assets (earth terminals, microwave systems, COMSEC equipment, fiber optics/cable, etc.).
- Installation, operation and maintenance of tactical interface, and sustaining base and strategic signal support functions (communications, automation, and network management) to sustain the warfighter in a geographic AOR.
- NETOPS at the installation level.
- Access to the LWN for all Army assets assigned to a geographic area and to tactical Army assets deployed in other theaters.
- Support to the brigade staff that is responsible for planning, coordinating, and supervising the brigade mission area functions.
- Advice to the commanders, staff, and information system users on the capabilities, limitations, and employment of all tactical and non-tactical signal and network assets available to a particular supported command.
- Advice to the supported commanders and staff on information management, automation policy, technical matters, performance, and supervision of system analysis and programming functions on related abilities.
- All-source intelligence assessments and estimates at the operational and strategic levels dealing with enemy capabilities, intentions, and vulnerabilities pertaining to the LWN and to the commander. This also entails predicting the enemy courses of action, producing threat estimates, ensuring proper dissemination

Chapter 4

of intelligence information and products, and evaluating intelligence products as they relate to the LWN and the GIG.

2D SIGNAL BRIGADE

4-19. This brigade is a subordinate command of NETCOM/9th SC(A) with OPCON vested in United States Army, European Command (USAREUR). The 2nd Signal Brigade's mission is to install, operate, and maintain the communications infrastructure and systems capable of extending the GIG on order to Army, joint, and combined forces.

21ST SIGNAL BRIGADE

4-20. This brigade is a subordinate command of NETCOM/9th SC(A). The 21st Signal Brigade's mission is to provide for the integration of telecommunications services that include tactical and fixed stations for the DOD and other federal agencies within CONUS and to provide visual documentation of US, allied, and hostile forces during combat operations and peacetime training exercises.

160TH SIGNAL BRIGADE

4-21. This brigade is a subordinate command of NETCOM/9th SC(A). The 160th Signal Brigade is OPCON to United States Army Central Command during peacetime. Its command and support relationships can change during wartime. Currently headquartered in SWA, the brigade has extended the LWN to the warfighter by installing commercial communications facilities and capabilities throughout the United States Central Command (CENTCOM). Their primary mission is to install, operate, and maintain strategic communications in an active theater of war.

516TH SIGNAL BRIGADE

4-22. This brigade is a subordinate command of 311th (SC[T]) with OPCON vested in the United States Army, Pacific Command (USARPAC). The 516th Signal Brigade's mission is to provide signal

support to Pacific warfighting forces, to provide theater information and communication systems policy and programming functions, and to advise the Commanding General, USARPAC, on resources required by major subordinate commands (MSCs) for C2 and communications system deployable assets.

STRATEGIC BATTALIONS, COMPANIES AND MODULES

4-23. NETCOM/9th SC(A) theater strategic signal battalions and companies provide the Army's worldwide strategic LWN information backbone that can be extended wherever combat forces deploy. These organizations can be found in both a strategic signal brigade and a tactical signal brigade. This seamless information infrastructure is operational 24 hours a day, 7 days a week, and 365 days a year. The network is a mix of tactical and commercial systems that capitalize on new and emerging technologies to provide enhanced capabilities to deployed and fixed station warfighters. NETCOM strategic units stationed in theaters of operation provide operational and strategic communications services to CCDRs and Army warfighters.

4-24. The strategic signal force structure is a critical element in enabling joint and expeditionary battle command communications across the full spectrum of operations. The following strategic battalion and company table of organization and equipment designs are based on capability requirements specific to that location's executive agent responsibilities and mission directives that were identified by NETCOM. Figure 4-2 represents the strategic design that is driving the new strategic force structure currently being implemented.

Battalion Headquarters

4-25. Battalion Headquarters provides C2, staff planning, and supervision of assigned and attached strategic signal units.

Chapter 4

Company Headquarters

4-26. Company Headquarters provides C2 and logistic support for the company. Its operations section is responsible for planning, coordinating, and supervising the operations of all company strategic communication and signal support missions.

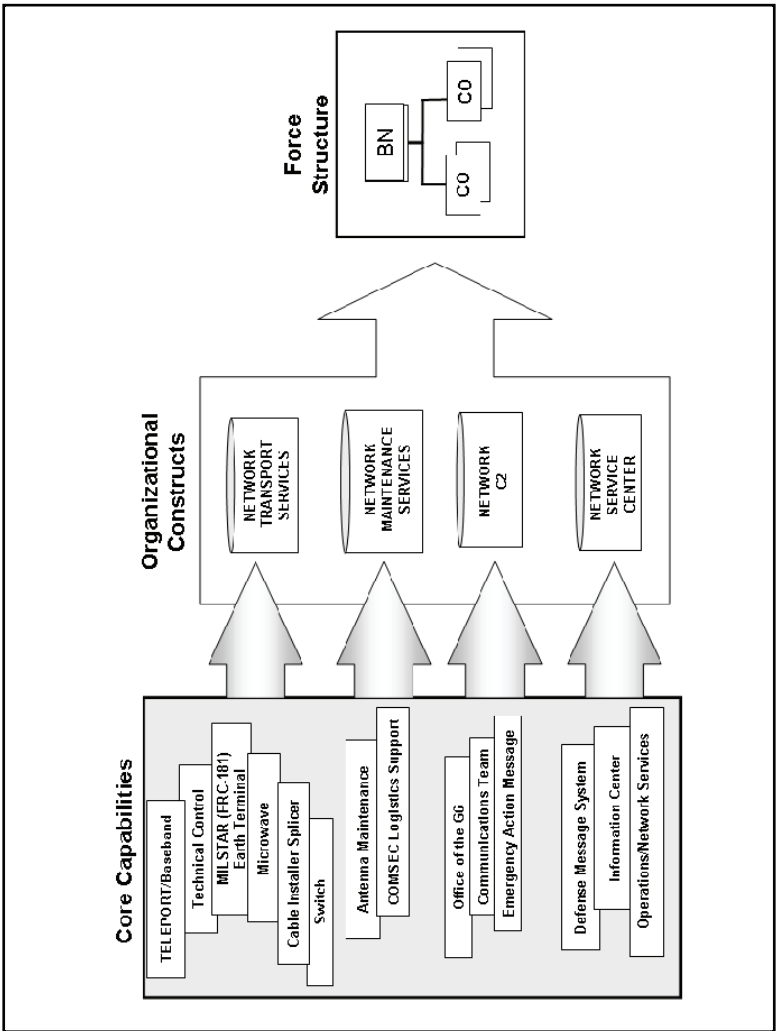

Figure 4-2. Strategic design

Chapter 4

4-27. The Network Service Center, Network Transport Services, Network Maintenance Services, and Network Command and Control are organizational constructs that were derived from consolidating like functions and small teams to create a standardized design that is based on a core capability.

Network Service Center

4-28. **NETOPS.** Responsible for planning, coordinating, and supervising the Network Service Center.

4-29. **Network Management Section.** Provides inside/outside plant operation and maintenance on digital telecommunication equipment.

4-30. **Data Network Administration Team.** Provides IA assistance for network systems unique to a geographic region, also LNO to Regional Network Operations and Security Center.

4-31. **Dial Central Office.** Provides inside/outside plant operation and maintenance on voice telecommunication equipment for a geographic region.

4-32. **Dial Service Assistance Switch Operations.** Provides information support and dial assistance for customers in a geographic region.

4-33. **Network Management Team.** Provides technical customer assistance and, as required, dispatches voice/digital touch labor maintainers for a geographic region.

4-34. **Video Telecommunication Hub.** Provides operation and maintenance of commercial Video Telecommunication Hub/Bridge for a geographic region.

4-35. **DMS/COMSEC Team.** Provides DMS organizational/individual electronic messaging and COMSEC material support for customers in a geographic region.

4-36. **Certification Authorization Workstation (CAW) Team.** Provides COMSEC material support and management for customers in a geographic region.

4-37. **DSN Switch (Defense System Network).** Provides operation and maintenance of a commercial and/or tactical electronic switching system for a geographic region.

4-38. **Area Support Team.** Provides installation, operation, and maintenance of commercial communication systems for a geographic region.

Network Transport Services

4-39. **Global Operations.** Responsible for planning, coordinating, and supervising the operations and maintenance of SATCOM terminal sites.

4-40. **SATCOM Terminal Teams.** Provide earth terminal communications as part of the Defense Satellite Communications System (DSCS), which is used to establish CDRs networks, emergency action message (EAM) dissemination, force direction, integrated tactical warning and assessment (ITW&A) reception, and summary transmissions.

4-41. **Baseband Teams.** Provide a tactical interface to the DSCS, which is used to establish CDRs networks, JTF networks, and EAM dissemination, force direction, and ITW&A reception and summary transmissions.

4-42. **Advanced Baseband Teams.** Provide additional commercial and military bands that provide a tactical interface to the DSCS using teleport as the baseband. Types of advanced baseband include the following: UFG, extremely high frequency (EHF), C, Ka, and Ku.

4-43. **Automated Technical Control.** Provides an intermediate level of OPCON and technical direction over Defense Communications System (DCS) facilities and systems, as required by DISA. The following identify the two different facility classifications:

Chapter 4

- Circuit (V) 1: technical control with 100 to 1000 circuits.
- Circuit (V) 2: technical control with 1000 + circuits.

4-44. **Microwave Teams.** Provide installation, operation, and maintenance of microwave communications for a geographic area.

4-45. **Cable Install/Splice Teams.** Provide permanent and emergency splicing of copper and fiber optic cable systems, as well as installation and maintenance of base support cable and wire systems within a geographic area.

Network Maintenance Services

4-46. **COMSEC Log Support Team.** Provides COMSEC custodian functions, COMSEC equipment maintenance, and COMSEC logistics functions to a geographic region.

4-47. **Antenna Maintenance Team.** Supervises the emergency and scheduled maintenance services and quality assurance inspections for antenna and antenna support structure of the Army and other government agencies.

4-48. **Long-Haul Maintenance Team.** Provides electronic equipment maintenance of communication systems, i.e. microwave. The team performs engineering quality control and continuity testing of microwave circuits, trunks, systems, and facilities.

Network C2

4-49. **EAM Systems.** Provide emergency and contingency communications to a region along the entire spectrum of conflict.

4-50. **ASCC/CCDR Communication Team.** Provides communications support in the form of secure frequency modulation radio, UHF TACSAT, record telecommunications message support, and COMSEC equipment maintenance to combatant and/or Army service component commanders.

4-51. **Communications Management Support Team (CMST).** Provides deployable communications support directly to Secret

Service agents engaged in protective missions for presidential candidates, visiting dignitaries, and other special events, as directed.

4-52. **Office of the G-6.** Provides plans, operations, staff oversight, and coordination for information and communication systems support to Army, Joint, and Combined Headquarters.

4-53. **MILGROUP COLUMBIA.** Provides supported commander communications assistance in the form of single channel TACSAT, high frequency (HF) radio, secure frequency modulation radio, non-tactical single channel radio, automated information and COMSEC installation, operation, and maintenance (IOM). It also provides signal advice, expertise, and training to non-signal personnel in supported units.

4-54. **JTF BRAVO Honduras.** Provides staff oversight, planning, coordination, management, and command of telecommunications system and information systems support functions support to combat and non-combat Army, Joint, and Combined Headquarters.

SECTION III – SIGNAL OPERATIONS

ORGANIZATIONS FOR THE MODULAR FORCE

4-55. In theater, the numbered Army is organized and equipped primarily as the ASCC for a geographical combatant command. To support command, control, telecommunications, and network requirements, the ASCC commander calls on several modular, multifunctional, scalable units that provide communications network support across theater echelons and spectrum of conflict.

ARMY SERVICE COMPONENT COMMAND G-6

4-56. Theater LWN greatly depends on many factors starting with the ASCC G-6. The ASCC G-6 is responsible for all LWN operations

Chapter 4

within a specified geographical region. The theater G-6 provides LWN support to the geographical combatant command, to Army units operating in the theater in support of the geographical combatant command, and to other services and joint elements as directed by the geographical combatant command and theater army commanders.

4-57. The ASCC G-6 serves as the theater senior signal officer providing network oversight of theater LWN and joint systems under its control. Additionally, the ASCC G-6 develops theater LWN requirements and manages the activities and resources needed to install, employ, and protect all operational and strategic networks supporting the ASCC and its subordinate forces. The ASCC G-6 will also ensure proper integration and protection of all tactical networks employed by maneuver and tactical forces at the corps/division and BCT levels to ensure those tactical commanders have the quality of service they need to prosecute the fight. Some duties of the ASCC G-6 are to—

- Provide and maintain NETOPS SA of the theater LWN environment and network asset availability.
- Maintain network status and provide oversight of NETOPS, changes, threats, and emerging requirements of the theater LWN.
- Provide internal IT support to ASCC headquarters.
- Execute and manage theater EMS management functions.
- Coordinate with host-nation communications authorities.
- Provide oversight of the theater CND posture.
- Oversee theater COMSEC operations to include storage, management, distribution, inspection, and compliance.
- Provide input to the TNCC and JNCC as required.
- Provide theater battlefield EMS management to include allotment, assignment, and control of radio and SATCOM frequencies for units assigned, attached, or OPCON to the ASCC and spectrum issues affecting joint, coalition, and host-nation agency requirements.

- Execute CIO functions for the theater and oversees theater enterprise programs, projects, and initiatives IAW Clinger-Cohen Act and Army regulation (AR) 25-1.
- Coordinate LWN IA activities with IO Cell, TNOSC, and RCERT and recommend theater information operations condition postures IAW G-2/G-3/IO.
- Act as JTF J-6 or JFLCC J-6/ARFOR G-6 as required.

JOINT COMMAND J-6 OFFICER

4-58. The J-6 officer serves on the combatant command staff as the communications director, and he may have dual responsibilities as the SC(T) commander. The J-6 officer assumes the role of the CCDR network manager with the establishment of a joint NETOPS control center that manages and controls all communications systems and networks deployed during joint operations and exercises. The joint NETOPS control center is the single control agency for the management and operational direction of all joint communications elements in the theater of operations. The NETOPS responsibilities of the J-6 officer are to —

- Formulate policy and guidance for all communications assets supporting the joint forces commander.
- Develop communications and information architectures and plans to support the mission of the CCDR.
- Develop policy and guidance for integrating and installing operational networks.
- Provide C2 of the joint information systems infrastructure.
- Exercise staff supervision and OPCON of the theater assets provided by DISA, other services, and other DOD agencies.
- Perform network management activities, functions, and tasks required to manage effectively and efficiently the joint information systems infrastructure and multinational networks supporting the CCDR mission.

Chapter 4

- Provide oversight of the theater NETOPS control center in the management and control of the CCDR's communications assets in theater.
- Adhere to COMSEC principles with the establishment of effective IA program initiatives.

J-6 and Communications Information Systems

4-59. Within the joint force operational headquarters, the J-6 communications information systems staff provides adequate support for joint operations and uses interoperable communications information systems procedures at all levels in the joint force. Where appropriate, the J-6 staff forms a Joint Information Communications Control Center, and its functions are to—

- Support the joint forces commander and the C2 facilities.
- Exercise supervision over communications and information activities, including EMSO and information security of subordinate commands and force components.
- Provide connectivity with the regional North Atlantic Treaty Organization and host nation's communications system, commercial communications, and adjacent commands.

Note. Most theater level signal assets are scheduled for reorganization. It is not uncommon for the senior signal organization in a theater to be a signal brigade as opposed to a SC(T). These brigade commanders will hold the same responsibilities as a SC(T) commander.

SIGNAL COMMAND (THEATER)

4-60. The SC(T) is the highest level, deployable organization in charge of theater LWN. It is a major subordinate command of NETCOM and operates OPCON of a supported ASCC. The SC(T) is

organized, equipped, and manned to plan, engineer, integrate, manage, and defend the Army's portion of the GIG with the mission of operating as the primary network provider for theater LWN. It exercises C2 over strategic and tactical organizations, the TNOSC, visual information (VI) resources, wire and cable and commercial infrastructures, and theater CE maintenance. Total force composition under the C2 of the SC(T) depends on METT-TC (Figure 4-3) and the CDRs' requirements.

4-61. A SC(T) or senior theater signal brigade provides signal support to the ASCC including MCO missions. The SC(T) C2s multiple theater signal brigades and joint and coalition information signal support elements. A signal brigade rather than a full SC(T) usually provides support to ASCC missions that do not involve MCOs.

4-62. The SC(T) HQs is a standard Table of Organization and Equipment design. To meet regional or theater-unique METT-TC-based requirements and combatant command's daily operational requirements, it may be necessary to provide an augmentation table of distribution and allowances and a modified table of organization and equipment exception authorization document to tailor the SC(T) to meet selected fixed infrastructure mission requirements.

4-63. The commander of the theater's senior signal organization SC(T) or signal brigade (tactical) serves as the theater G-6. While the SC(T) commander receives mission orders from the ASCC commander, the SC(T) also performs network management through technical channels via HQ NETCOM, the applicable Geographical Combatant Command J-6, and the United States Strategic Command/JTF-GNO for service and global enterprise management, technical compliance, and network defense.

4-64. The SC(T) depends on other organizations for large-scale communication infrastructure architecture engineering support; theater facility engineering support; health services; human resource, finance, and administrative services; troop transportation support; and legal services. The SC(T) depends on the ASCC for theater COMSEC and EMS management.

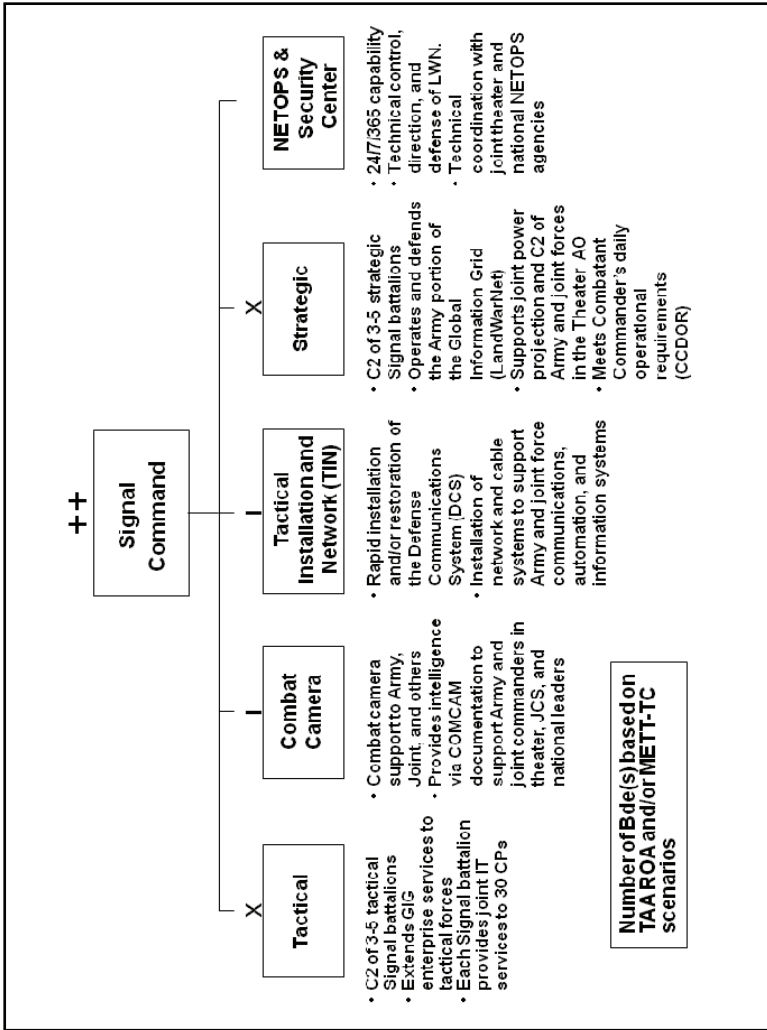

Figure 4-3. SC(T) subordinate elements

4-65. The SC(T)'s mission is also to—

- Provide C2 and supervision for units assigned, attached, and OPCON to the SC(T).
- Provide a staff component for various operational commands including JTF J-6, JFLCC J-6, ARFOR G-6, and corps/division G-6.
- Support early entry mission requirements.
- Provide operational management of signal assets responsible for install, operate, maintain and defend (IOM-D) theater LWN to include centralized management of voice, data, messaging, and VTC capabilities.
- Provide IA management supporting information protection for theater LWN systems.
- Develop policies and procedures for IA support in order to protect, detect, and react to the ACERT strategies as directed by the ASCC G-6.
- When tasked, establish the JNCC with augmentation from other services or provide the Army's portion to the JNCC, once established.
- Provide oversight to the TNOSC.
- Plan, engineer, and manage signal support systems installed by the SC(T) and network interfaces to existing systems installed by joint, combined, and allied units.
- Plan, engineer, and manage requirements for special-purpose communications/information systems.
- Provide planning and staff management of the GMFs/TACSAT Theater SATCOM Monitoring Center and Army GMFs in the theater of operations.
- Work closely with the DISA and ASCC G-6 concerning DISN matters to include coordinating with host-nation communications organizations for planning and using commercial and host-nation assets within theater.

Chapter 4

- Provide planning, staff supervision, and coordination of SC(T) logistics, public affairs, and command information programs, inspector general matters, comptroller services concerning programming, budgeting, and controlling funds, and to facilitate engineering support.
- Provide coordination of operations and planning and to evaluate and prepare reports of chemical, biological, radiological, and nuclear activities throughout the SC(T) affecting signal assets.
- Provide theater VI units supporting the ASCC.
- Provide software management for units assigned, attached, or OPCON to the SC(T), to include managing all applications and proprietary software, managing all noncombatant service support software, and advising the ASCC G-6 staff on software and application matters pertaining to NETOPS.

4-66. The SC(T) can expect to deploy any part or the entire organization to meet METT-TC requirements. It will operate in a manner to support LWN requirements in theater, whether as a forward element, operating in sanctuary, or from a power projection platform. It must be able to direct the execution of sustaining base, strategic, and tactical information and communication systems supporting Army, joint, and coalition operations during all phases. Ideally, the SC(T) center of mass will locate where the commander can best exercise C2 over signal assets, influence theater network schemes and architectures, and overall best meet network requirements supporting the ASCC commander or JFC.

5th SC(T)

4-67. This command is OPCON to USAREUR and Seventh Army. The commanding general also serves as the Deputy Chief of Staff, G-6 (CIO) for USAREUR and Seventh Army. The 5th SC(T) mission is to provide a combat-ready, forward-deployed signal force providing responsive theater tactical, strategic, and installation signal support to NATO and US Soldiers in the USEUCOM across the spectrum of operations. The 5th SC(T) is also capable of meeting requirements to

support worldwide contingencies in response to the joint staff, HQDA, and NETCOM directives to install, operate, and restore theater tactical communications across the spectrum of conflict.

7th SC(T)

4-68. The 7th SC(T) is OPCON to FORSCOM and, when fully operational, will consist of two regionally based signal brigades: the 93rd Signal Brigade providing signal support to CONUS West and the 106th Signal Brigade providing signal support to CONUS East. This will be the single command responsible for the operation and defense of the CONUS LWN. The 21st Signal Brigade and the CONUS Theater Network Operations and Security Center will also be assigned to the 7th SC(T). Figure 4-4 shows the organization of the 7th SC(T). The commanding general of the 7th SC(T) also serves as the FORSCOM G-6.

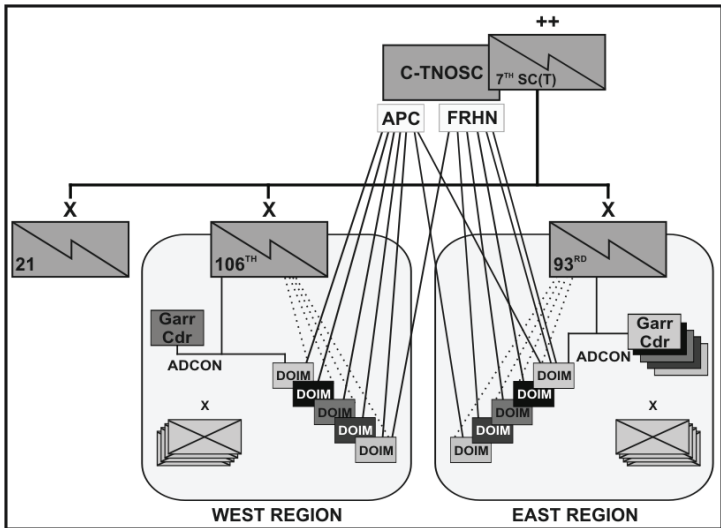

Figure 4-4. 7TH SC(T) organization

Chapter 4

4-69. The 7th SC(T) exercises technical and tactical control over all Army NETOPS service providers in the CONUS theater. The command will provide access to network services, data and applications that allow units to rehearse as they fight, seamlessly train and deploy enabling the units to maintain their operational tempo through all operational phases

4-70. Currently, the Directorates of Information Management (DOIMs), within their regionally aligned areas, supports expeditionary units as they deploy, redeploy, and retrain using the ARFORGEN model. There are currently approximately 137 installation DOIMs. The 7th SC(T) will assume this responsibility and create a unified, standard method of providing this support.

311th SC(T)

4-71. The 311th is the designated SC(T) for the USARPAC. The 311th SC(T) is a United States Army Reserve Command (USARC) flagged multi-component organization that is under the OPCON of USARPAC. The 311th SC(T) receives ADCON support from both NETCOM/9th SC(A) and the USARC. The commander of the 311th SC(T) is multi-missioned as the Deputy Chief of Staff, G-6 of USARPAC, the RCIO for installation management control Pacific Region, and the J-6 of the JTF-Homeland Defense.

335th SC(T)

4-72. This command is a multi-component SC(T) (USAR flagged) with the mission to manage telecommunications infrastructure for SWA (South Asia, Middle East, North Africa) in support of the United States Army, Central Command (USARCENT)/3rd Army for US Central Command during peacetime and contingency operations. In peacetime, the USARC commands the unit. In wartime, the unit is under the command of the NETCOM and under the OPCON of CENTCOM. The commander of the 335th serves as the ARFOR G-6 or JTF J-6 of the supported force.

THEATER TACTICAL SIGNAL BRIGADE

4-73. Tactical brigades and battalions extend information network services to the deployed Army HQ and other deployed subordinate organizations allocated to the Army's AO. Tactical units are not organic to a signal command, but are allocated based on mission requirements. Network assets are apportioned to supported units according to METT-TC and the supported unit's specific communications and network requirements.

4-74. The mission of the theater tactical signal brigade (TTSB) is to C2 up to five tactical battalions and any other assigned or attached forces necessary to meet the network support missions in the theater of operations. The TTSB is equipped, manned, and organized to provide C2 functions and staff assistance to the subordinate units, staff supervision, personnel actions and administration, and logistics actions. TTSBs are forces assigned to NETCOM and OPCON to specific supported CCDRs, service component commanders, or JTF commanders. TTSB contains the normal headquarters and staff elements found in other tactical formations (Figure 4-5). The TTSB—

- Conducts systems planning, transport, and infrastructure engineering.
- Develops architecture, design, and integration studies.
- Determines technical circuit characteristics.
- Develops plans for establishing communications systems.
- Provides field support and sustainment support to operational missions in the form of ESBs.
- Can provide a span of control for echelons above corps (EAC) signal support to JOA.
- Provides passive and value-added services to Army Forces within the JOA, including common user services and continuity of operations facilities.

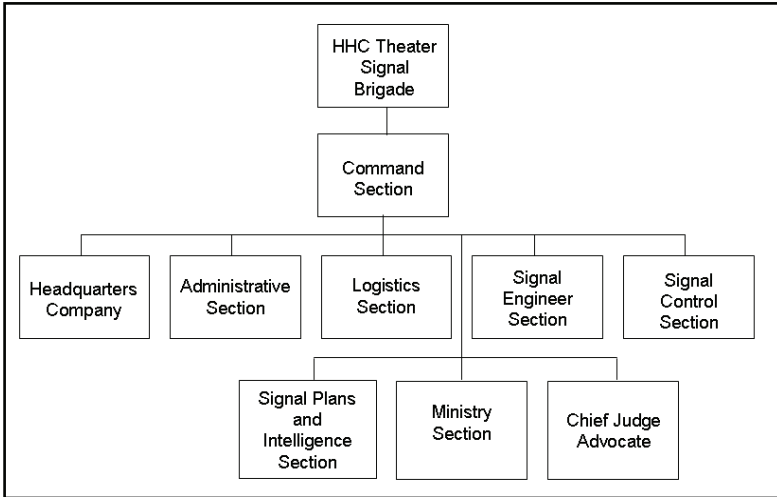

Figure 4-5. Theater tactical signal brigade

Headquarters Company, TTSB

4-75. The S-1 is responsible for all human resources and administrative functions in the brigade, to include advising the commander on all human resource related issues and providing legal advice and assistance, supported by personnel of the Judge Advocate General Corps.

4-76. The logistics staff officer (S-4) provides oversight for all and logistics plans and functions for the brigade. This section also advises the brigade commander on all matters pertaining to logistics, transportation, deployment, and maintenance.

4-77. The communications operations section for the brigade (S-3) conducts detailed systems integration and network planning functions for the brigade. This section is also responsible for—

- Determining equipment suitability and adaptability with existing communications systems.
- Ascertaining the types of installations and employment required to provide quality transmission over installed circuits and systems.

- Handling frequency requests and associated records for the brigade units.
- Establishing the brigade communications systems control element (CSCE) responsible for keeping network situational understanding and status of current and future needs for rerouting or reconstituting circuits and facilities throughout the communications system.
- Providing effective operational management and responsive systems control.
- Taking appropriate actions to optimize the deployed network performance in response to constantly changing network configurations.
- Establishing and maintaining required databases necessary to assist in near real-time control of communications systems and to assist the signal plans and intelligence section in systems planning and engineering.

Note. The majority of the following signal brigades will become a theater's senior signal organization to perform more effectively and efficiently the Service Title 10 functions that support the transformed campaign-quality operating force with joint and expeditionary capabilities.

1st Signal Brigade

4-78. This brigade provides OPCON support to United States Forces, Korea (USFK) and 8th US Army in the Korean theater of operations. The 1st Signal Brigade commander serves a dual role as the 8th Army G-6 with an augmenting staff provided by the 311th SC(T). The 1st Signal Brigade is unique in that it has both tactical and strategic battalions assigned which provide a combat-ready, forward-deployed LWN capability for responsive theater tactical, strategic, and installation signal support to CCDRs, the United Nations Command, Combined Forces Command, USFK, and warfighters in the 8th Army

Chapter 4

area across the spectrum of operations. During wartime, the 1st Signal Brigade comes under the OPCON of the 311th SC(T) for the USPACOM or 8th Army AO.

7th Signal Brigade

4-79. This brigade provides OPCON support to USAREUR. It maintains a combat-ready, forward-deployed signal force to deploy, install, operate, and maintain seamless theater tactical information system support to US and NATO warfighters in the USAREUR/USEUCOM AOR.

11th Signal Brigade

4-80. This brigade is a CONUS based unit that is regionally focused to provide theater level and special tactical requirements to support USCENTCOM, USARCEN, and USPACOM, as required. The 11th Signal Brigade also provides support to worldwide contingencies in response to the joint staff, HQDA, and NETCOM mission directives to install, operate, maintain, and restore LWN systems across any spectrum of conflict to include support to the BCT level, as necessary. The 11th Signal Brigade provides a forward stationing presence using the 54th Signal Battalion in order to meet daily signal and DOIM support in the USCENTCOM AOR.

35th Signal Brigade

4-81. This brigade is a CONUS based unit that is regionally focused to provide theater level and special tactical requirements to support United States Army South (USARSO). The 35th Signal Brigade commander serves a dual role as the USARSO/G-6. The 35th Signal Brigade can also support worldwide contingencies in response to the joint staff, HQDA, and NETCOM directives to install, operate, and restore theater tactical communications across the spectrum of conflict.

228th Signal Brigade and the 261st Signal Brigade

4-82. These brigades are ARNG tactical brigades under the command of the ARNG during peacetime. Their mission focus is homeland defense and CONUS contingency requirements. In wartime, the units are under the command of NETCOM and are assigned IAW applicable operation plans.

359th Signal Brigade

4-83. This brigade is an USAR TTSB under the command of the USARC and the 335th SC(T). In wartime, the unit is commanded by NETCOM and is assigned IAW applicable operation plans.

THEATER SIGNAL MAINTENANCE COMPANY

4-84. The theater signal maintenance company (TSMC) is a one of kind unit that, with its current structure, supports the TTSB as an initial-entry deployer, providing immediate readiness of all ground support equipment to facilitate the critical theater signal mission. It also provides rapid deployable and dedicated general support and limited depot signal support for a theater of operations for the TTSB.

4-85. The 556th TSMC is assigned to the 11th Signal Brigade and the current structure includes a HQ platoon and three maintenance platoons. When deployed, the TSMC supports MCO by using a dedicated platoon as required (usually one platoon per MCO) to support TTSBs.

4-86. The TSMC's mission is to provide dedicated sustainment maintenance and class IX supply support to a theater of operations for TRI-TAC, MSE, computers, and conventional CE end items and components.

4-87. The TSMC provides a maintenance control section for theater unique and common signal assemblages. It also provides a dedicated authorized stockage list and prescribed load list elements for common and exclusive theater signal systems that are not necessarily demand

Chapter 4

supported but require intense control and management for the gaining brigade. The following are its repair and support capabilities:

- Modules, circuit boards/cards for high demand, high usage, and low-density theater signal assemblages.
- Automated data processing equipment (including teletype, Tactical Army Combat Service Support Computer System, and associated peripherals).
- HF communications equipment.
- Microwave equipment (including multichannel, TACSAT, and Tropospheric Scatter [TROPO]).
- Fabricates both copper and fiber optic cables for unique applications.
- Communications security equipment (including a specialized support activity for selected controlled cryptographic items).
- Ground support equipment (including power generation units with outputs up to 200 Kw, environmental control units, forced air heaters, power-driven decontamination equipment, and gasoline engines).

EXPEDITIONARY SIGNAL BATTALION

4-88. Over the course of the past several years and with the onset of the global war on terror, theater signal has undergone significant change to meet the information demands of CCDRs and joint forces. In step with the Army transition and modularity the integrated theater signal battalion (ITSB) was developed. These signal assets reside at the Army echelon as a “force pool” and can deploy across the entire spectrum of conflict in any segment of a theater, while supporting a larger and more diverse customer base. Few signal battalions converted to the ITSB design and provided the theater a modular, multi-capable, deployable unit that met the information and network requirements needed at most levels. Later it was found that the MSE switching and LOS systems employed by the ITSB structure could not provide the data bandwidth requirements of supported units at all echelons.

4-89. With the introduction of the next generation switch and data systems, it was found that signal battalions could be structured in a way that better enabled employment of network assets to support the increased number of medium and small command posts. These augmentations spurred the concept of an enhanced version of the ITSB that transformed into a modular expeditionary-capable signal formation known today as the ESB.

Note. The ESB is formally known as an integrated theater signal battalion–joint network node (ITSB-J). With the accelerated fielding to equip signal battalions with JNN, the approved naming convention of “ESB” was established.

4-90. While primarily a theater level asset, the ESB may be employed to support a corps/division, BCT, or service component, or coalition headquarters based on METT-TC. Although the ESB is typically assigned to a TTSB, it may be assigned or attached to other higher-level organizations as well, or may operate as part of a separate network package supporting specific missions such as Homeland Defense.

4-91. The ESB design simplifies the overall C2 of signal assets. As a modular element, it eliminates the need to task organize from multiple organizations to form a single communications support package, thereby enhancing unit cohesion and deployment planning, supporting “train-as-you-fight” and ensuring faster training for signal leaders in a systems-centric environment. The ESB also simplifies network-training requirements by facilitating end-to-end systems level training versus training in single function environments. Each battalion has the capability to link back to the sustaining base, as well as provide other C2 linkages to intra-theater nodes as needed.

4-92. The introduction of next generation switch/data systems and the reduction in the number of large switches has allowed the ESB to be structured in a way that better enables employment of network assets to support the increased number of medium and small command

Chapter 4

posts. This flexible structure improves the ESB's ability to respond quickly to support missions with precisely sized capabilities down to the team level that minimize the deployed signal footprint. The total support capability of the ESB has grown from 15 to 30 command posts.

4-93. The ESB design, as depicted in Figure 4-6, provides a multifunctional structure that—

- Supports theater elements operating in both theater and corps/division areas.
- Leverages current equipment for immediate standup while providing a modernization path to incorporate JNTC-S or WIN-T systems as resources become available.
- Applies to all Active and Reserve components.
- Is designed for the MCO fight and is capable of executing missions across full spectrum operations.

ESB Structure and Functions

4-94. The ESB consists of a battalion headquarters and headquarters company (HHC), two identical expeditionary signal companies, and a joint/area signal company.

4-95. **Battalion Headquarters.** The ESB HQ staff performs C2, administrative logistics, and force protection functions to support the commander in executing the battalion's mission. The battalion headquarters requires 100 percent mobility (the ability to transport all organic personnel and equipment in a single lift).

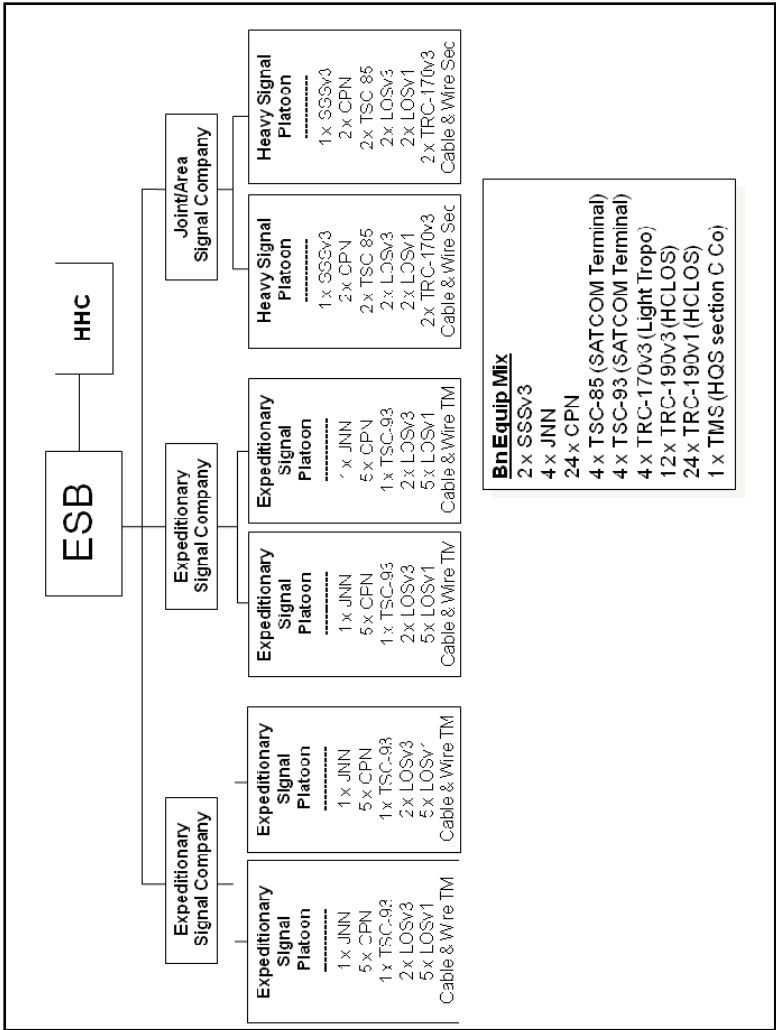

Figure 4-6. The ESB structure

Chapter 4

4-96. **Headquarters Company.** The battalion headquarters company provides personnel and facilities for C2 and coordination of the company mission. Personnel and equipment are provided for coordination and oversight of company administration, supply, force protection, and field-level maintenance of wheeled vehicles, power generation equipment, CE equipment, and small arms. The company headquarters provides food service in a field environment. The company requires 100 percent mobility (the ability to transport all organic personnel and equipment in a single lift).

Expeditionary Signal Company

4-97. The expeditionary signal company is designed to provide network services to small and medium command posts. The company consists of a company headquarters and two identical Expeditionary Signal Platoons (ESPs).

4-98. **Company HQ.** The company headquarters provides personnel and facilities for C2 and coordination of the company mission. Personnel and equipment are provided for coordination and oversight of company operations, administration, supply, and force protection functions. Soldiers are provided to conduct field-level maintenance of wheeled vehicles, power generation equipment, CE equipment, environmental control equipment, and small arms. The company headquarters provides food service in a field environment.

4-99. **ESP.** Each ESP consists of a JNN Team, two LOS V3 Teams, five CPN Teams, five LOS V1 Teams, a TACSAT Terminal Team, and a Cable Team. Typical platoon missions include the installation, operation, and maintenance of communication systems in support of battalion and brigade-level command posts. The platoon may be tasked to dispatch individual teams to separate support missions or to be combined with other teams, platoons, or companies to meet specific mission requirements at any echelon. Normally the LOS V1 teams will only be employed with a CPN.

Joint/Area Signal Company

4-100. The joint/area signal company is designed to provide network services to medium and large command posts and command post clusters. The company consists of a company headquarters and two identical Heavy Signal Platoons.

4-101. **Company HQ.** The company headquarters provides personnel and facilities for C2 and coordination of the company mission. Personnel and equipment are provided for coordination and oversight of company administration, supply, force protection, and field-level maintenance of wheeled vehicles, power generation equipment, CE equipment, environmental control equipment, and small arms. The company headquarters provides food service in a field environment. The TMS Section is in the company headquarters.

4-102. **Heavy Signal Platoon.** The Heavy Signal Platoon consists of a Switch Section, two LOS V3 Teams, two CPN Teams, two LOS V1 Teams, two Light TROPO Terminal Teams, two TACSAT Hub Teams, and a Cable Section with two cable teams. With its larger switches and heavier BLOS transmission capabilities, the platoon is suited to support large command posts, command post clusters, or support bases. The platoon can also support battalion- and brigade-level command posts, and may be tasked to dispatch individual teams to separate support missions or to be combined with other teams, platoons, or companies to meet specific mission requirements.

Operational Employment

4-103. The ESB is designed to afford network planners flexibility in configuring resources to meet user requirements precisely. In keeping with modularity principles, the ESB and its signal companies, platoons, and teams may be tailored and task organized so that only the precise package of capabilities needed to satisfy a given mission is deployed. In the same manner, companies, platoons, or teams may be added to an ESB to meet the demands of a particular mission.

Chapter 4

4-104. The ESB and its subordinate elements may be tasked to support organizations anywhere in a theater AO, to include army-level units provisioned to division-level support brigades. Network support missions may require a full battalion, a company, or a platoon; however, missions may require the deployment of individual teams to support separate units in widely dispersed locations at every echelon of an operation. Mission orders will normally be issued by the Army G-3 in coordination with the Army G-6 and disseminated to the ESB through the SC(T) HQ and tactical signal brigade HQ.

4-105. In a MCO, the theater army G-3 in coordination with the theater army G-6 will normally issue mission orders. Mission orders will be disseminated to the ESB through the SC(T) headquarters and tactical signal brigade HQ.

4-106. ESB subordinate companies, platoons, sections, and teams attached to supported units will normally receive logistical support, to include rations, petroleum, oils, lubricants, ammunition, medical care, repair parts, and maintenance services from the supported unit. Support requirements will be specified in the attachment order.

Command Relationships

4-107. ESBs are assigned to tactical signal brigades. Tactical signal brigades are assigned either to a SC(T) or to NETCOM/9th SC(A). Tactical signal brigades are aligned to support numbered armies (USAREUR/7th Army, USARPAC/8th Army, USARCENT/3rd Army, USARSO/6th Army, and USARNORTH/5th Army).

4-108. When assigned a network support mission, ESBs and subordinate elements will be detached from the parent unit and attached to the supported unit for the duration of the mission.

TACTICAL INSTALLATION AND NETWORK COMPANY

4-109. The Tactical Installation and Network (TIN) company provides large network infrastructure installation and rapid installation and restoration of the DCS within an Army's AO.

Growing from a need to provide responsive and agile advanced network installation services for critical missions, the TIN company has the capability to restore or install critical pieces of the DCS, which includes the DSN, the DSCS, and the DISN. Thorough planning identifies the necessary work requirements, specific core competencies, an estimated bill of materials, and personnel requirements.

4-110. The TIN company—

- Provides follow-on tactical support to signal packages for semi-permanent and permanent tactical automation, network installation, and information system support utilizing user provided bills of materials.
- Provides rapid DCS installation and restoration.
- Deploys in support of combatant commands, JTF, JFLCCs, ASCC, and SC(T)s. May be employed to support other service component or coalition headquarters, permanent or semi-permanent enclaves.
- Provides technical expertise to interpret and implement engineering plans for communication systems.
- Advises the supported commander on aspects of network installation to include inside plant, outside plant, LAN installation and initialization.
- Performs quality assurance testing and handoff of installed and restored systems.
- Installs, maintains, and repairs aerial, buried, or underground cable, wire, and fiber optic transmission systems.
- Repairs and maintains indigenous cable, wire, and fiber optic systems, and provides antenna and tower construction and repair.
- Provides LAN installation and cabling using any mix of military and commercial standards and materials.
- Provides automation support to include LAN initialization, network security, DMS, DRSN, SIPRNET, NIPRNET, and VTC.
- Installs or restores the DSCS terminal.
- Installs or restores a strategic to tactical interface path.

4-111. One TIN company typically deploys to an Army's AO. The company may be attached or OPCON to a SC(T) HQ, an ITSB, ESB or TTSB, an ARFOR or JFLCC G-6/J-6 staff section or under an organization responsible for joint communications until an Army signal headquarters deploys into theater. Platoons, sections, and teams can operate autonomously to support various locations, base clusters, and enclaves. The TIN company can also deploy tasked organized teams, sections, or platoons to support contingencies in CONUS and OCONUS. The organization structure for a TIN company is depicted in Figure 4-7.

VISUAL INFORMATION

4-112. *Visual information (VI)* is information in the form of visual or pictorial representations of person(s), place(s), or thing(s), with or without sound. VI includes still photographs, digital still images, motion pictures, analog and digital video recordings, and hand- or computer-generated graphic art and animations that depict real or imaginary person(s), place(s), and/or thing(s), and related captions, overlays, and intellectual control data (Joint Publication [JP] 1-02).

4-113. The mission of VI activities and Soldiers is to acquire and provide the President, Office of the Secretary of Defense (OSD), Joint Staff, military departments, and Army commanders with record documentation, multimedia/VI products, and services to satisfy official requirements.

4-114. Security classification, operations security or subject sensitivity should not be used to prevent visual information documentation (VIDOC), since VI products can be classified at any level required. VIDOC is the process of using motion media, still photography, and audio equipment to acquire audio and visual records of events. Resulting VI products include photographs, motion pictures, video recordings, graphic art, visual aids, models, and displays.

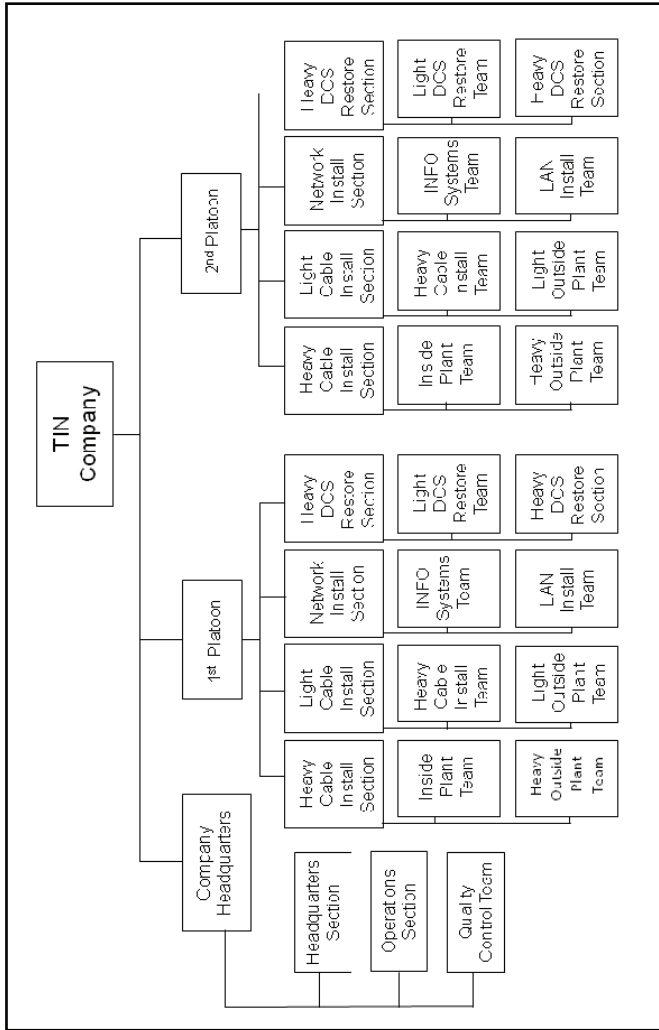

Figure 4-7. Theater TIN company

Chapter 4

4-115. VI products assist commanders at all levels by providing a visual record of significant Army events and activities. Visual images are used in tactical C2 decision making, strategic planning, and management through presentations and reports. Doctrinal, combat, materiel, and training developers use VI records for analysis and in reports and briefings to support their programs. VI products can be used for historical purposes to document training, educational, research, logistical, personnel, medical, and legal activities. VI with historical or long-term value shall be stored, managed and preserved by the Defense Imagery Management Operations Center (DIMOC).

4-116. The DIMOC is the new operational arm of the Defense Visual Information directorate. It is a transformational organization that has assumed the missions, functions, and responsibilities of the Joint Combat Camera Center, the Defense Visual Information Center, and the Joint Visual Information Services Distribution Activity and will serve as:

- The central reception and distribution point for all joint interest still and motion imagery.
- The designated central records center for storage, preservation, and distribution of general purpose Defense imagery.
- The central life-cycle management and initial/follow-on distribution activity for DOD productions, providing post-production services for DOD and other government customers.

COMBAT CAMERA

4-117. The mission of combat camera (COMCAM) forces is to provide the OSD, Chairman of the Joint Chiefs of Staff, the Military Departments, combatant commands, and JTFs with a directed imagery capability in support of operational and planning requirements during wartime operations, worldwide crises, contingencies, and joint exercises (FM 3-55.12). The COMCAM mission is to support but is independent from, unique imagery operations such as Public Affairs, psychological operations, intelligence, and civil support. The Army's theater COMCAM

company accomplishes its mission by providing COMCAM tactical support to joint and US Army operations and exercises.

4-118. The COMCAM company can provide land, airborne, and airmobile operations. When deployed as a whole, it supports warfighters at all echelons across the spectrum of conflict in the theater of war. Its modular design facilitates tailoring support packages for lesser regional conflicts, small-scale contingencies, and other operations in the spectrum, such as peacekeeping and humanitarian relief operations. The company can deploy on short notice to support any level of combat force projection down to the brigade combat team. It can also operate in a joint operational environment as part of, or in support of, a joint COMCAM organization.

4-119. The COMCAM company provides the following capabilities—

- Staff planning, control, and supervision of the operations of the company, to include any augmenting personnel or materiel assets.
- COMCAM equipment maintenance by minor on-site repair, replacement, or evacuation to civilian contractors.
- Liaison to supported units, joint collection management tools and other service COMCAM elements.
- Establishment, operation, and maintenance of COMCAM facilities supporting theater Army and subordinate TAC CP headquarters. This includes—
 - COMCAM editing for the electronic processing of digital still and motion imagery acquired by organic documentation teams, weapons system video, or other COMCAM field units located in the theater Army AOR.
 - Operating support facilities to provide tailored still and motion media products, graphics products, narration support, and video reports on short suspense.

- Presentation and exploitation of visual imagery to support operational requirements.
- COMCAM platoons to support operational requirements and provide continuous COMCAM documentation for historical purposes, to include ground and aerial documentation/acquisition of visual imagery. Transmission is accomplished via the most reliable transmission means available; that is CNRs, single-channel TACSAT radios, local area networks, or Defense Switched Network (DSN) and commercial telephone lines.
- VI and documentation support to Army units with missions across the spectrum of conflict from peacetime military engagement to MCOs.

Support Requirements

4-120. At the theater level, the COMCAM company is attached to the theater army and is co-located with the G-3. The theater army element provides support and services under the warfighting functions. Under the warfighting functions support is provided for transmission of VI on data-capable communications lines across the theater and back to the sustaining base. The theater army provides CE maintenance support to the COMCAM company.

4-121. At the corps and division levels, the COMCAM element is attached to the headquarters. The platoon headquarters is co-located with the appropriate corps/division G-3. COMCAM teams are under the OPCON of the brigade and battalion headquarters and are co-located with the appropriate unit S-3. The associated Army element provides food service, health, legal, religious, financial management, human resources, administrative services, supply, supplemental air transportation, and support for transmission of VI on data-capable communications lines across the corps/division and to the next higher headquarters. The corresponding signal command provides CE maintenance support.

Structure

4-122. The modular design of the COMCAM company has been standardized to facilitate their mission requirements at the tactical level of operations to more accurately reflect its emerging role in strategic and tactical requirements. The structure of the theater COMCAM company consists of a company headquarters, two corps support platoons, and five division support platoons. Figure 4-8 outlines the structure of a typical theater COMCAM company.

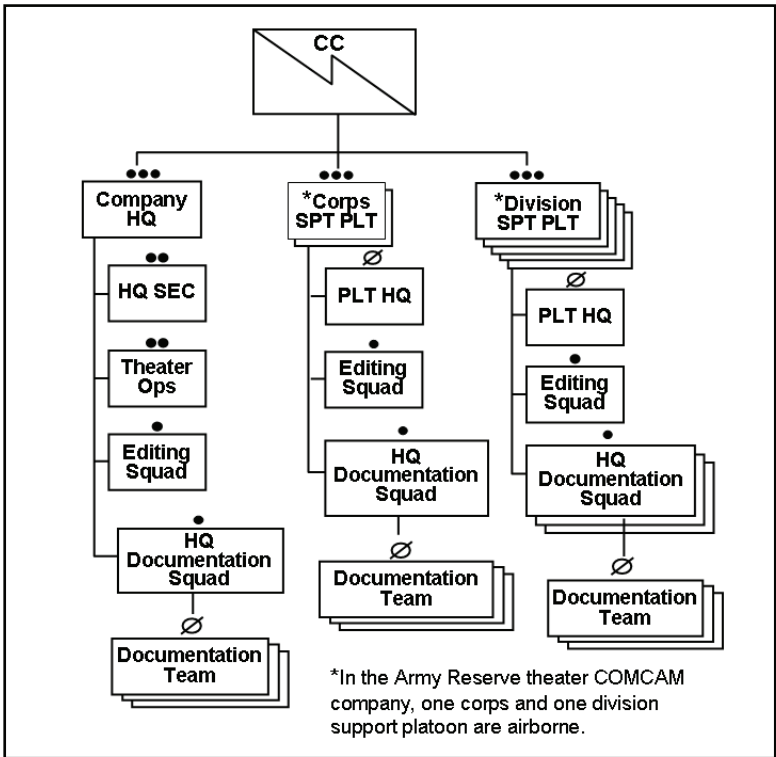

Figure 4-8. Theater COMCAM company

JOINT COMBAT CAMERA OPERATIONS

4-123. COMCAM empowers the joint force commander by acquiring, processing and distributing classified and unclassified still and motion imagery in support of full spectrum operations. Inclusive documentation ensures an accurate record of ongoing operations, and is vital to the strategic communication mission. Each military Service has dedicated COMCAM units that are specially trained and equipped to support combat forces in any environment. All COMCAM personnel must have received advanced field training and weapons qualifications. All personnel who require access to information systems processing classified defense information to fulfill their duties will possess a security clearance based on the appropriate personnel security investigation per Department of Defense Directive (DODD) 5200.2. When employed, COMCAM supports the force at all echelons in a theater of war. The COMCAM force packages are adaptive, fully qualified and equipped to document sustained day and night operations.

4-124. Army COMCAM teams will be tasked to participate in DOD joint exercises along with COMCAM teams from other services. Only the Chairman, Joint Chiefs of Staff and combatant commanders have the authority to task joint service COMCAM teams. Tasking is normally component-specific (Army COMCAM is tasked to document Army activities); however in a joint environment, joint COMCAM forces can be formed to document all aspects of an operation. Imagery provided will be provided to the JTF commander and supported elements, while simultaneously and expeditiously transmitted to the DIMOC. COMCAM products cleared by the operational commander can be forwarded directly from the theater of operations to the DIMOC for further distribution to the operational staff.

4-125. The Commanding General, US Army Network Enterprise Technology Command (NETCOM)/9th Signal Command (Army) [SC(A)] organizes and operates Army deployable COMCAM units through the 55th Signal Company (COMCAM) (Regular Army) and

the 982nd Signal Company (COMCAM) (Army Reserve) to provide visual documentation of operational contingencies, exercises, joint operations, and relief activities in response to major disasters and other peacetime engagements.

THEATER NETWORK OPERATIONS AND SECURITY CENTER

4-126. The TNOSC operates, manages, and defends the LWN in order to deliver seamless information and communication systems capabilities in support of all in-theater Army entities in its AO. The TNOSC executes its NETOPS responsibilities in coordination with the Army G-6. RNOSCs may execute TNOSC functions on a geographic basis within their AOR under tactical control of the TNOSC. The responsibilities of the TNOSC are to control performance of technical functions of both fixed theater network infrastructure and tactical Army signal units within the theater AOR.

TNOSC Deployment Support Division

4-127. In conjunction with the modular restructuring of the Army, the signal command is undergoing revision in order to support emerging requirements of the new modular force. One such revision is the addition of a new Deployment Support Division (DSD) within the TNOSC. The DSD has the primary responsibility for all TNOSC support to deployed forces. It is comprised of two branches: the Tactical Network Team (TNT) and the Tactical Integration Cell (TIC) as shown (with the other TNOSC divisions) in Figure 4-9.

Tactical Network Team

4-128. The TNT is a fully deployable NETOPS entity (but based on METT-TC it is not necessarily fully or always deployed). The TNT acts as a fully integrated NOSC providing NETOPS functions for the SC(T) commander or signal brigade commander. The TNT will leverage supporting capabilities of the ASCC TNOSC to execute its NETOPS functions. The ARFOR TNT monitors, manages, and

Chapter 4

controls inter-BCT, division and corps, and EAC information network components.

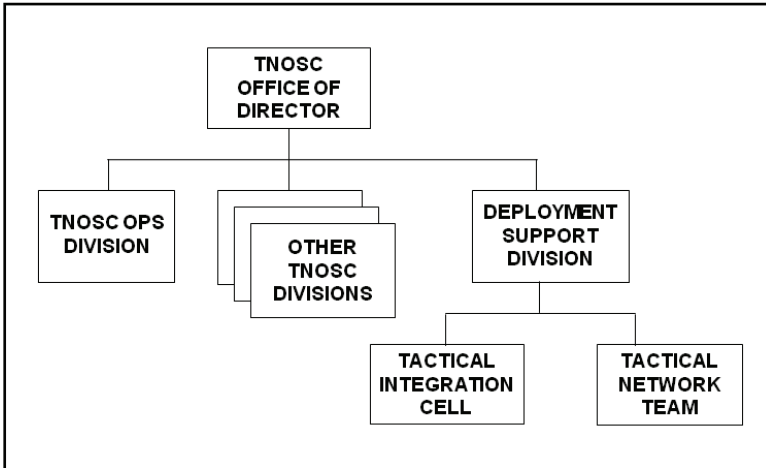

Figure 4-9. TNOSC DSD structure

Tactical Integration Cell

4-129. The TIC is a body of tactical network personnel within the DSD of the TNOSC that is dedicated to the integration and support of NETOPS for tactical units. The TIC provides the following functions:

- Oversight and management of tactical ASCC NETOPS support services, such as the tactical NETOPS systems.
- Supplementary or backup network services in direct support of other network elements as required. These services include storage and directory, as requested by the ARFOR. These functions are value-added services and are not intended to replace critical organic NETOPS assets within the chain of command.
- Technical subject matter expertise upon request to analyze and resolve tactical network problems and incidents.

- Coordination of any required interoperation of ASCC NETOPS systems with tactical NETOPS systems such as e-mail, collaboration, DNS, and directory services.
- Any necessary system interfaces, equipment augmentation, or NETOPS processes to enable standard Army tactical forces to interoperate seamlessly with combatant command's specific requirements and policies.

4-130. The TIC responsibilities also include the formation of temporary Tactical Liaison Teams (TLTs), which are dedicated to the support of a specific tactical unit. The TLT performs a liaison function to the supported unit's NETOPS cell, providing essential integration services between the tactical unit and the respective TNOSC, while also providing valuable technical NETOPS augmentation to the unit's organic NETOPS capability. When supporting a corps/division or corps/division-based command, a TLT typically collocates with corps/division personnel at the tactical Network Service Center. TLT personnel in support of an expeditionary BCT may perform functions from the TNOSC, or may relocate to other locations as missions dictate. Figures 4-10 and Figure 4-11 depict the two typical scenarios for these elements.

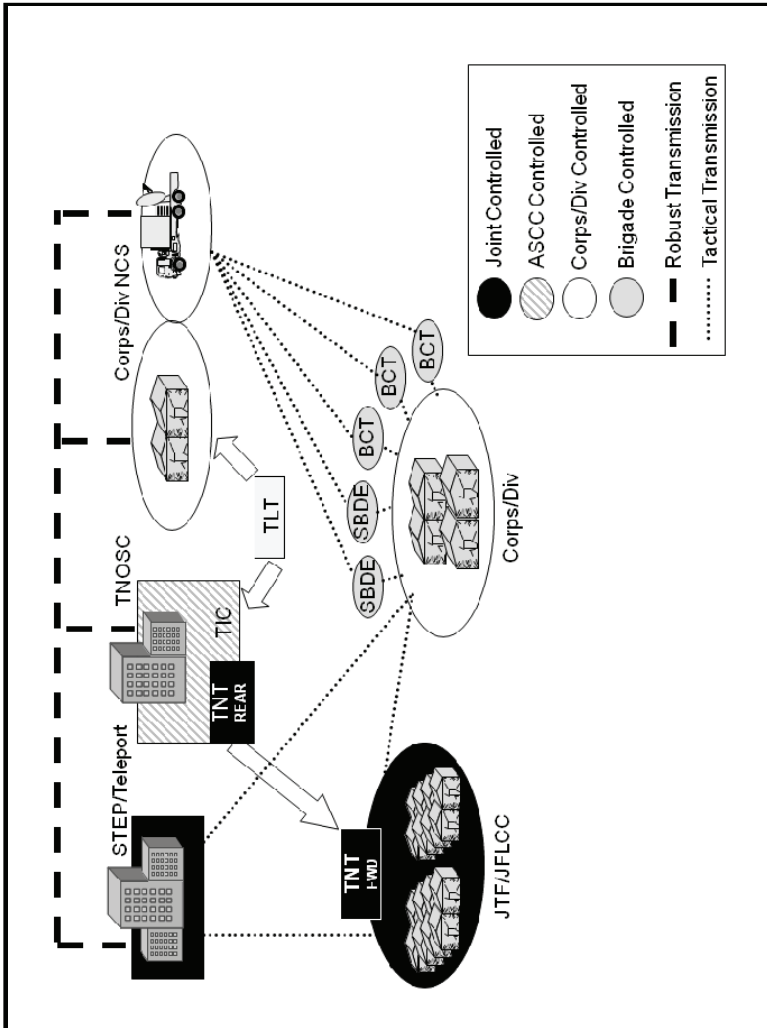

Figure 4-10. TNOSC DSD elements—TNT, TIC, and TLT with corps/division

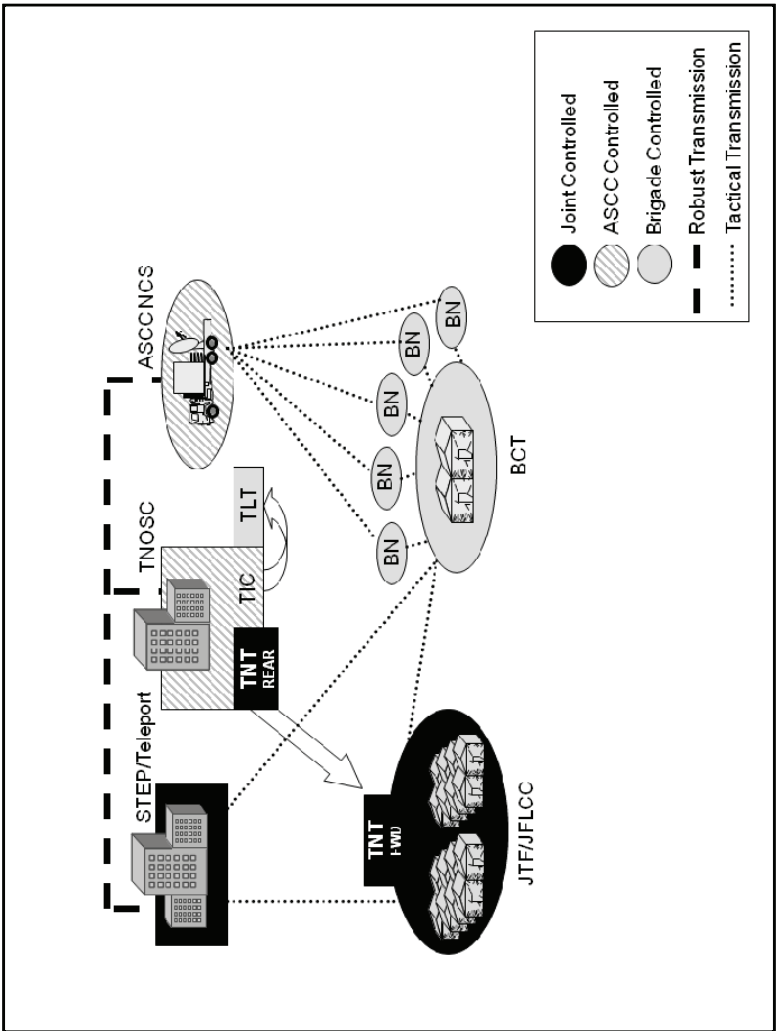

Figure 4-11. TNOSC DSD elements—TNT, TIC, and TLT without corps/division

This page intentionally left blank.

Chapter 5

Transport Systems

The Army's transformation has provided enhanced network equipment capabilities to the modular force. The major network transport systems for the modular and current force are the communications systems currently being fielded under WIN-T Increment 1. This chapter includes a section on MSE and the Tri-Service Tactical (TRI-TAC) systems to provide information until the transformation of WIN-T Increment 1 is complete. This chapter provides commanders and G-6/S-6 leaders an understanding of the LWN transport systems at corps and below.

WIN-T INCREMENT 1

5-1. WIN-T Increment 1 was formerly known as Joint Network Node-Network (JNN-N) and is the network enabler fielded to provide timely, network-enabled support to tactical modular formations, providing connectivity from a battalion to the GIG.

5-2. The major components of the WIN-T Increment 1 transport are the hub node, (fixed, mobile, and tactical); the JNN at corps, division, and brigade; and the CPN at battalion.

Chapter 5

5-3. The JNN is the communications package deployed at corps, division and brigade levels. The JNN enables independent operations and direct termination into the theater network, GIG, or a joint headquarters. The JNN facilitates the management of digital groups, trunks, and circuits. It provides the means through which the communications resource at a node can be monitored, controlled, and managed. The JNN capabilities include Ethernet switching, IP routing, network management, and network security services that include network intrusion detection.

5-4. The JNN has voice and data switching equipment allowing independent operations and enabling both circuit switching and IP based networking. The JNN will work with existing terrestrial transport (LOS and HCLOS), ground mobile forces (AN/TSC-85/93), TROPO (AN/TRC-170), SMART-T (AN/TSC-154), Phoenix SATCOM terminal (AN/TSC-156), and commercial Ku-band satellite or Ka-band satellite, when available.

5-5. Networking capabilities provided by JNN to support network enabled voice, data, and video services support include—

- Forty-eight two-wire phone subscribers (SIPRNET and NIPRNET).
- Twenty-four IP voice subscribers (SIPRNET and NIPRNET).
- Forty-six IP data subscribers (SIPRNET and NIPRNET).
- Includes 24 data subscribers connected to IP phones.
- One local Private Branch Exchange; 1.544 Mbps or tier 1 T1 trunk.
- Eight MSE black long voice subscribers.
- Defense Red Switch Network long local access to the AN/TRC-170 via a Pairgain modem.
- Remote battlefield video teleconferencing center access to the AN/TRC-170 via a Pairgain modem.
- Supports two MSE digital transmission group supporting voice and data.

5-6. Critical communications components of the JNN are the vantage MSE gateway switch, a private branch exchange, Cisco router, Promina multiplexer, Cisco call manager, Ku-band TDMA, and FDMA modems, satellite transportable terminal (Ku-band satellite), and tactical LAN encryptor. Figure 5-1 shows WIN-T Increment 1 architecture at different echelons.

Note. Refer to FMI 6-02.60 for more information on WIN-T Increment 1.

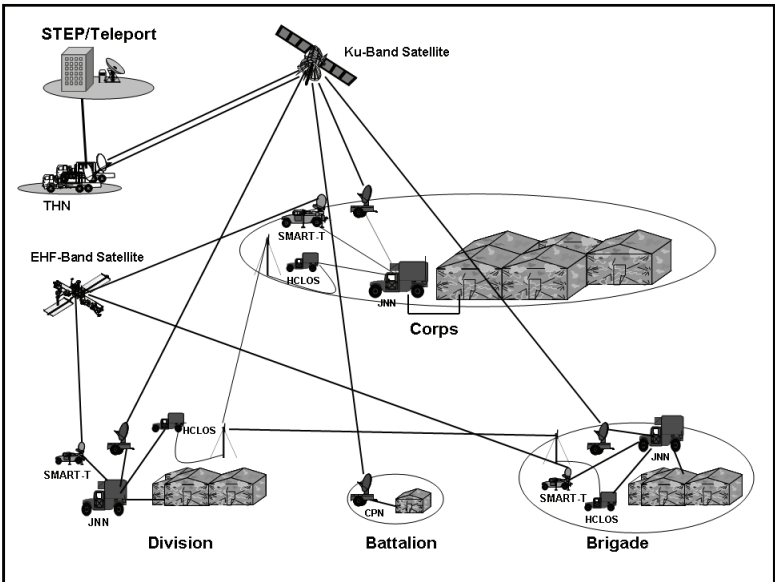

Figure 5-1. WIN-T Increment 1 architecture

WIN-T INCREMENT 1 HUB NODES

5-7. The hub node is the primary component of the network service center. The network service center links the TDMA and FDMA Ku-band architectures. Additionally, the network service center allows for the termination, reallocation, and control of network bandwidth.

Fixed Regional Hub Node

5-8. The FRHN is a theater asset that provides coverage for units deploying to a geographical region. There will be five FRHNs when they are fully operational: one each within the Central Command, Pacific Command, and European Command and two within the CONUS. They will provide near-worldwide coverage when operational. The FRHN may provide initial hub support for the units in theater prior to the arrival of the division THN or if the commander makes the decision not to employ the THN. Control of the network may be transferred to the THN as the mission and situation dictates.

5-9. The FRHN can support up to three divisions concurrently and has the flexibility to provide support to autonomous BCTs as well as ESBs that are task organized to support all echelons. The FRHN provides the following capabilities to the division—

- Primary hub node connectivity and services during reception, staging, onward movement, and integration operations.
- Continuity of operations for MRHNs and THNs.
- A server sanctuary supporting the delivery of theater level services to the corps, division, and brigade.
- Assured reachback to the Trojan Network Control Centers for TOP SECRET/Sensitive Compartmented Information users supported by a JNN or CPN as their point of entry to the network.

5-10. The FRHN will be collocated with a STEP or teleport facility providing an always-on high bandwidth access to the GIG and

extension of DISA services to the division. The FRHN consists of a communications facility, which contains the satellite and baseband equipment, and a services facility, which contains servers and network and system administration personnel. The theater signal brigade personnel will operate and maintain the FRHN.

5-11. A liaison team from the supported unit will ordinarily deploy to the FRHN to assist with configuration of the Tier 2 equipment that interfaces with their forces based on METT-TC. This Tier 2 equipment includes routers, switches, call managers, and NETOPS. This team will also facilitate NETOPS and troubleshooting issues. The liaison team will remain at the FRHN as the mission dictates.

5-12. If a THN of the division assumes control of the network after arriving in theater, it may be necessary for the liaison team to transfer to the THN and the FRHN would become a backup capability for the division providing continuity of operations if needed. It would then be possible for the division technicians to remotely access the FRHN Tier 2 devices that support them as required. The division or corps G-6 will coordinate as early as possible with the signal brigade S-3 to define liaison support activities at the FRHN. Any Tier 2 application servers installed at the FRHN will be configured and managed by the liaison team.

Tactical Hub Node

5-13. The THN is the primary hub node supporting a division and its subordinate units and is organic to the division signal company. It will ordinarily deploy to a sanctuary location to provide connectivity to a DOD gateway either with the division headquarters or in advance of the division headquarters. As the corps has no organic hub node, the THN may be used by the corps to provide access to the GIG and to control its subordinate units. Additionally, if elements of an ESB are OPCON to support the corps, division, or brigade, they may use the THN as an entry point to the network. The THN is capable of interfacing with current Army systems such as mobile subscriber

Chapter 5

equipment (MSE) and Tri-Services Tactical Communications Program (TRI-TAC).

5-14. The THN is made of two identical TDMA/FDMA SATCOM shelters and one baseband shelter. The SATCOM shelters have a 3.9-meter Ku/Ka capable antenna. Each shelter contains 8 TDMA and 8 FDMA modems for 16 TDMA and 16 FDMA modems per THN. There is a master reference terminal and network control center in each shelter. The THN has the capability to provide services to a division network of 16 FDMA CPs and 80 TDMA CPs. The baseband shelter contains the necessary components to interface with the DOD gateway and provides the following capabilities—

- Multiplexing.
- Link encryption.
- IP encryption (KG-175).
- Patching and testing.
- Private Branch Exchange phone service with Defense Switched Network connectivity.
- Tier ½ NIPRNET and SIPRNET routing services.
- Tier 2 NIPRNET and SIPRNET routing services.
- IA (e.g., intrusion detection, firewall, and deep packet inspection).
- Voice over Internet Protocol.
- Secure voice over Internet Protocol.

Network Service Center-Training

5-15. The Network Service Center-Training is located at the US Army Signal Center, Fort Gordon, Georgia. The Network Service Center-Training has capabilities similar to a THN with a primary mission of providing TDMA and DISN training and sustainment services for WIN-T Increment 1 equipped units in CONUS, Hawaii, and Alaska. The Network Service Center-Training supports activities such as home station training, Battle Command Training Center training, and Combat Training Center rotations. It also provides formal

schoolhouse training to prepare Soldiers to operate, manage, and interface with WIN-T Increment 1 assets. The Network Service Center-Training performs the following functions—

- Provides TDMA master reference terminal services for sustainment training networks.
- Remotely monitors, controls, and troubleshoots remote TDMA networks.
- Establishes a test bed for experimentation and prototyping.
- Supports development of doctrine and tactics, techniques, and procedures.
- Supports, as necessary, real-world operations.
- Provides a vehicle for individual training and live network collective training exercises.
- Supports mobile training teams.

Mobile Regional Hub Node

5-16. The MRHNs are the original hub nodes fielded to the 3rd Infantry Division and will be transitioned to the NETCOM/9th SC(A) to serve as MRHNs. They consist of the same assemblages as the THNs with the difference being that they are mounted on commercial vehicles. The MRHNs will be allocated to, operated, and maintained by theater signal brigades. Each MRHN is capable of providing network services to a typical division consisting of 100 CPs on TDMA and 16 CPs on FDMA. A MHRN has the following capabilities—

- Provides coverage in areas where an FRHN has not been built or provides no coverage.
- Provides hub node connectivity to expeditionary units (e.g., BCTs) not deploying with a THN.
- Supplements a FRHN when additional capacity or satellite coverage is required.
- Provides TDMA management support enabling intra-theater brigade to brigade level routing and network services.

Chapter 5

- Provides unit sustainment training and exercise support.
- Supports expeditionary BCTs operating independent of a THN supported division.

COMMAND POST NODE

5-17. The CPN is primarily fielded to the battalion level headquarters, but it is also used to augment a CP at other echelons. It consists of a support vehicle, a trailer-mounted 2.4 meter satellite dish, and two transit cases.

5-18. The CPN (refer to Figure 5-2) operates in the TDMA satellite architecture providing secret data and Voice over Internet Protocol phone services. This architecture allows the battalion data network to terminate into the JNN and network service centers. The CPN has the following characteristics—

- Interfaces with satellite and LOS assets.
- Is IP voice only.
- Is one physical enclave (tunnel second).
- Capable of using bursts up to 4 Mbps on TDMA.



Figure 5-2. Command post node

BRIGADE SUBSCRIBER NODE

5-19. The brigade subscriber node (BSN) is fielded in SBCTs that are not already JNN enabled. The BSN provides switching, routing, transmission, network management, and security services within a single shelter. These components form the communications network infrastructure that enables the user to transfer voice, video, data, and imagery information throughout the AO. The SBCT signal company contains two BSNs and are traditionally placed at the brigade main CP and the brigade support area CP. The BSN is capable of interfacing with the JNN, MSE, and TRI-TAC.

NETWORK OPERATIONS CENTER-VEHICLE

5-20. The Network Operations Center-Vehicle (NOC-V) is found within select SBCT signal companies as well as battalion level headquarters. The NOC-V provides the S-6 with an operational facility and an integrated means to plan, manage, monitor and control tactical systems and networks that are within their management domain. The NOC-V provides voice and data services as well as radio links to the lower tactical Internet via SINCGARS, EPLRS and NTDR radios. It also contains a Force XXI Battle Command Brigade and Below (FBCB2) suite and tactical Internet manager for SA message traffic, tactical Internet, and TOC management. The NOC-V is capable of interfacing with the strategic, commercial, joint, and multinational data communication systems through the BSN.

HIGH-CAPACITY LINE OF SIGHT SYSTEM

5-21. The AN/TRC-190(V)3 is a terrestrial microwave radio system containing three AN/GRC-245 HCLOS radios. Each radio provides full duplex digital traffic at rates up to 16,384 kilobits per second (kbps). It is found within the signal companies at the corps, division, and brigade. It is ordinarily paired with a JNN to provide a high bandwidth LOS capability of up to 40 kilometers when terrestrial LOS

exists. The AN/TRC-190(V)1 contains one HCLOS radio and is found in units that use the CPN.

SECURE MOBILE ANTI-JAM RELIABLE TACTICAL TERMINAL

5-22. The SMART-T is a satellite ground communications terminal that is found within the corps, division, and brigade signal companies. It provides a protected SATCOM path for range extension of JNN systems that is capable of both single-channel voice communications and high bandwidth data transfer of up to 1.544 Mbps. SMART-T uses the Military Strategic Tactical Relay satellite constellation and employs frequency hopping technology that prevents jamming and interference from affecting communications. SMART-T is a one-vehicle system that can be put into operation by one Soldier in less than 30 minutes.

WIDEBAND SATELLITE TERMINALS

5-23. The AN/TSC-85C and AN/TSC-93C terminals are current forces' ground mobile forces systems. The terminals are tri-band multichannel communications terminals that operate in the SHF spectrum with a throughput capacity up to 8.448 Mbps. The C models are being replaced by the D models to extend their life and provide greater capabilities. They are found within the ESB and are used to augment the internal assets of the corps, division, and brigade such as when a theater asset is attached or OPCON to them. The multi-band Phoenix AN/TSC-156 SATCOM terminal replaces selected AN/TSC-85/93 terminals in the ESB.

COMMERCIAL SATELLITE COMMUNICATIONS TERMINALS

5-24. Commercial SATCOM terminals are used primarily in stability operations to free up tactical assets. These are unit funded and procured systems that receive no DOD funding. The terminals include fixed, deployable, VSAT, and mobile products. Training, spares, and operations and support services are ordinarily provided as required. The two prevalent terminals are covered below.

AN/USC-60A Flyaway Tri-band Satellite Terminal

5-25. The AN/USC-60A Flyaway Tri-band Satellite Terminal is a transportable tri-Band (C, X, Ku Band) transit case packaged SATCOM terminal. It employs a unifold 2.4-meter antenna system and can set up or torn down in less than 60 minutes. The modular architecture of the AN/USC-60A terminals easily accommodates expansions such as a digital video, digital voice/facsimile transmission, secure communication, and network control.

5-26. The AN/USC-60A is ordinarily used as a spoke in a hub and spoke network but may also be configured to act as the hub. It is possible to upgrade the AN/USC-60A to make it compatible with Ka Band satellites.

Deployable Ku Band Earth Terminal

5-27. The Deployable Ku band Earth Terminal (DKET) is a satellite terminal capable of supporting 24 T1 data rate circuits through a 4.6-7 meter tracking antenna. It contains redundant RF electronics and auto uplink power control with an environmentally controlled shelter with redundant generators and UPS for critical components. The digital fiber optic interface system connects to user baseband up to 2 km. The DKET is Interoperable with all tri-band satellite terminals and teleport earth terminals in commercial bands. The DKET is employed as a hub to service large populations. (There is a Ka Band upgrade kit available for the DKET.)

MOBILE SUBSCRIBER EQUIPMENT

5-28. The MSE system is the forerunner of the WIN-T Increment 1 suite of equipment currently fielded to many of the reorganized modular units. It is an area-switched communications system that relies primarily on LOS links up to 40 km (28 miles) apart, but can operate on a satellite network if the satellite systems are provided. The use of relay assemblages can increase the distance between LOS nodes.

Chapter 5

5-29. The MSE system provides both voice and data communications on an automatic, discrete-addressed, fixed-directory basis using flood-search routing. The system supports both mobile and wire subscribers with a means to exchange C2 information in a dynamic tactical environment.

5-30. MSE was designed to provide communications in an area of operation of up to 37,500 square km (15,000 square miles). The system is digital, secure, and highly flexible. MSE also contains features that deal with link or functional element outages, traffic overload, and rapid movement of users.

5-31. Throughout the maneuver area, subscribers connect to extension nodes by radio or wire. These extension nodes serve as local call switching centers and provide access to the network by connecting to a node center.

MSE Components

5-32. Node centers provide essential switching, traffic control, and access points for MSE. After determining the coverage area, node centers are allocated to establish a corps MSE grid network. Node centers are primarily linked by LOS radios to provide communications throughout the system via the node center switch. The cable connects TACSAT and TROPO systems to the node center. If one node center is disabled, the system automatically routes communications through another node center. The node center switch serves as an access point for large extension nodes (LENs), small extension nodes (SENs), radio access unit, system control center-2s, and Integrated System Control (ISYSCON).

5-33. The forced entry switch combines the essential functions of the node center switch, LEN, node management facility, and a radio access unit into one shelter. The forced entry switch, combined with a LOS AN/TRC-198, comprises the contingency communications package.

5-34. The LEN switch provides wired communications for personnel at large CPs. A LEN switch enables up to 164-wired subscribers to communicate freely using automatic flood search routing.

5-35. The SEN switch supports the communications needs of smaller CPs. The AN/TTC-48 (V)1 can support 26-wired subscribers and the (V)2 can support 41-wired subscribers.

5-36. The radio access unit, AN/TRC-191, is a fully automatic radio interface for mobile subscriber radiotelephone terminal subscribers. It connects directly to the node center by cable or remotely via LOS radio. The radio access unit is capable of terminating a maximum of eight radio telephone calls at any one time. The planning range between the mobile subscriber radiotelephone terminal and the radio access unit is 15 km (9.3 miles).

5-37. The ISYSCON is the automated, theater-wide, tactical-communications network-management system used to plan, configure, monitor, and control the entire spectrum of military tactical communications systems. ISYSCON features include mission plan management, network planning and engineering, battlefield frequency spectrum management, tactical packet network management, and WAN management. (Refer to Appendix A for more information on battlefield spectrum management.)

5-38. The AN/TRC-190 (V)1 is an LOS multi-channel radio terminal. It provides point-to-point UHF radio links using the AN/GRC-226 (P) radio set between various nodes of the MSE system. The (V)1 is equipped with one AB-1339 mast with Band I and Band III antennas. The planning range of the UHF radio is 40 km (28 miles).

5-39. The AN/TRC-190 (V)2 is an LOS multi-channel radio terminal. It provides point-to-point UHF radio links using the AN/GRC-226 (P) radio set between various nodes of the MSE system. The (V)2 is equipped with two AN/GRC-226(P) radio sets (one online and one spare) and one AB-1339 mast with Band I and Band III antennas. The planning range of the UHF radio is 40 km (28 miles). The (V)2

Chapter 5

typically deploys as an analog interface to North Atlantic Treaty Organization forces.

5-40. The AN/TRC-190 (V)3 is an LOS multi-channel radio terminal. It provides point-to-point UHF radio links using the AN/GRC-226 (P) radio set between various nodes of the MSE system. The (V)3 is equipped with four AN/GRC-226(P) radio sets (three online and one spare) and three AB-1339 masts with two Band I and two Band III antennas. The planning range of the UHF radio is 40 km (28 miles). Each radio link supports a single full-duplex group-level connection and a single digital voice orderwire channel. The AN/TRC-190 (V)3 typically deploys with the node center switch and is a radio relay.

5-41. The AN/TRC-190 (V)4 is an LOS multi-channel radio terminal. It provides point-to-point UHF radio links using the AN/GRC-226 (P) radio set between various nodes of the MSE system. Each radio link supports a single full-duplex group-level connection and a single digital voice orderwire channel. The AN/TRC-190 (V)4 is equipped with two AN/GRC-226 (P) radio sets (two online) and two AB-1339 masts with Band I and Band III antennas. The planning range of the UHF radio is 40 km (28 miles). If the AN/TRC-190 (V)4 has an AN/GRC-224 (P) radio set installed, it can provide a short-range, down the hill, and point-to-point SHF radio link. The AN/TRC-190 (V)4 typically deploys with the LEN switch.

TRI-SERVICE TACTICAL

5-42. Currently, if TRI-TAC systems are used they are employed at the theater level. Similar to MSE, the TRI-TAC network forms a communications grid of area nodes, which covers the AO. The area nodes normally interconnect by LOS links up to 40 km (28 miles) apart. Users gain access to the network at many extension nodes, which tie into the area nodes through LOS links. The use of relay assemblages can increase the distance between nodes. TACSAT and TROPO links further extend the range between nodes.

Chapter 6

Federation of Networks

This chapter provides an overview of the federations of networks that are most commonly used today. The reader is referred to additional publications for detailed information on subject matter beyond the scope of the chapter. As communications needs grow, new networks will be acquired. This chapter does not represent all communications assets currently available to commanders and signal leaders.

INTRODUCTION

6-1. The federation of networks are specialized networks and systems that are commonly referred to as “stovepipes” and will continue to operate until fully integrated into a single enterprise. These stovepipes are designed to meet a commander’s unique intelligence, operational, and sustainment needs. They serve a narrow community of users and have limited or no interoperability with other systems. These networks are required by different warfighting functions, many of which are not directly installed, operated, or maintained by signal personnel. The following paragraphs discuss some of the most widely used systems.

COMBAT NET RADIOS

6-2. The primary role of CNR is voice transmission for C2. The secondary role includes data transmission where other data capabilities do not exist. The CNR is primarily designed around the SINCGARS, the single channel TACSAT, and the high frequency radio.

6-3. More tactical radios with these or like capabilities are found at division and below. Each of these systems has different capabilities and transmission characteristics.

Note. Refer to other doctrinal publications that may be accessed on the doctrine AKO portal at <http://gordon.army.mil/doctrine> for more information on tactical radios being used throughout the Army. The portal requires a common access card to access.

BLUE FORCE TRACKING

6-4. The BFT system is an L-band SATCOM tracking and communication system that provides the commander eyes on the friendly forces and the ability to send and receive text messages. BFT operates with FBCB2 software. FBCB2s terrestrial-based radio is EPLRS, a networking radio that provides transport and position location when necessary.

6-5. The BFT contains computer hardware and software, interconnecting cables, L-band satellite transceiver, a precision lightweight global positioning system receiver, a mission data loader to transfer larger files, and an installation kit appropriate to the host vehicle type (if applicable). Other major BFT systems include the Movement Tracking System and Talon Reach. (Refer to FMI 6-02.45 for more information on these systems.)

ARMY BATTLE COMMAND SYSTEM

6-6. ABCS is the integration of primarily user-owned and –operated automated systems. These information subsystems access critical warfighting functions and information resident on other similar warfighting systems in a seamless and secure manner. ABCS is a common hardware system (CHS) and a core set of common support software, which is functionally unique to each sub-system.

Note. These integrated information systems allow commanders and their staff access to real or near-real time information in the full spectrum of military operations. Refer to Appendix B for an overview of the ABCS information systems and services.

COMBAT SERVICE SUPPORT VERY SMALL APERTURE TERMINAL

6-7. The Combat Service Support Very Small Aperture Terminal (CSS VSAT) SATCOM system provides wideband NIPRNET connectivity to all major sustainment nodes across the Army. The CSS VSAT enables deployed maneuver and support battalions to reach key sites located in the CONUS and in sanctuary. The CSS VSAT is combined with the wireless Combat Service Support Automated Information Systems Interface (CAISI) to provide flexible connectivity for sustainment systems such as the property book unit supply enhanced. Figure 6-1 illustrates the CSS VSAT architecture.

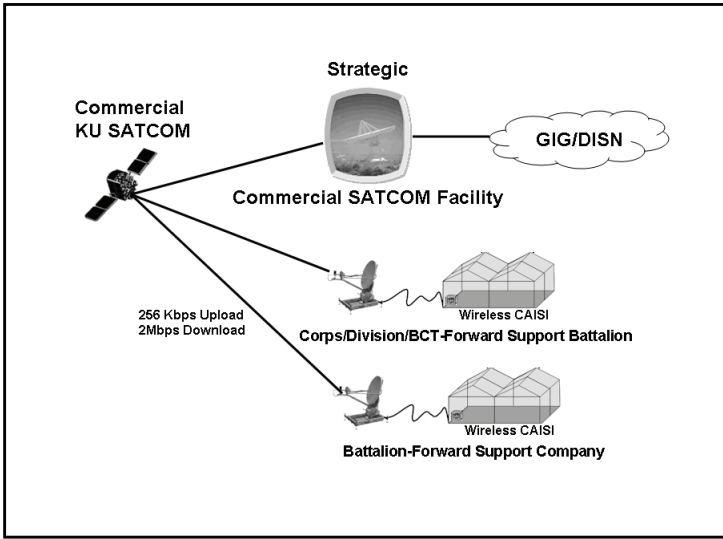

Figure 6-1. CSS VSAT architecture

COMBAT SERVICE SUPPORT AUTOMATED INFORMATION SYSTEMS INTERFACE BRIDGE MODULE

6-8. The CAISI is a wireless LAN that provides tactical network connections for logistics and health service support information systems. The CAISI bridge module serves as the LAN server and connects up to 112 individual logistics systems through the CSS VSAT to the global internet grid. CAISI can transmit and receive signals in a clear LOS range of up to four miles. The CAISI bridge is operated by the S-4 (logistics staff officer) section. Systems that use CAISI include—

- CSS VSAT.
- Battle Command Sustainment and Support System.
- Transportation Coordinators' Automated Information for Movement System (V II).

- Medical Communications for Combat Casualty Care (MC4).
- Standard Army Ammunition System.

TROJAN SPECIAL PURPOSE INTEGRATED REMOTE INTELLIGENCE TERMINAL

6-9. Trojan SPIRIT is a military intelligence operated system that is a critical network enabler for the commander and the intelligence elements. It is currently the primary network capability connecting the deployed user to TOP SECRET/Sensitive Compartmented Information networks that include the Joint Worldwide Intelligence Communications System and the National Security Agency network. The data may be either delivered over a dedicated Trojan SPIRIT suite or tunneled through the JNN components via KG-175 tactical fast lane in-line network encryption devices. Figure 6-2 depicts the Trojan SPIRIT at corps, division, or brigade being tunneled through the JNN to other points of presence that do not have a dedicated Trojan SPIRIT.

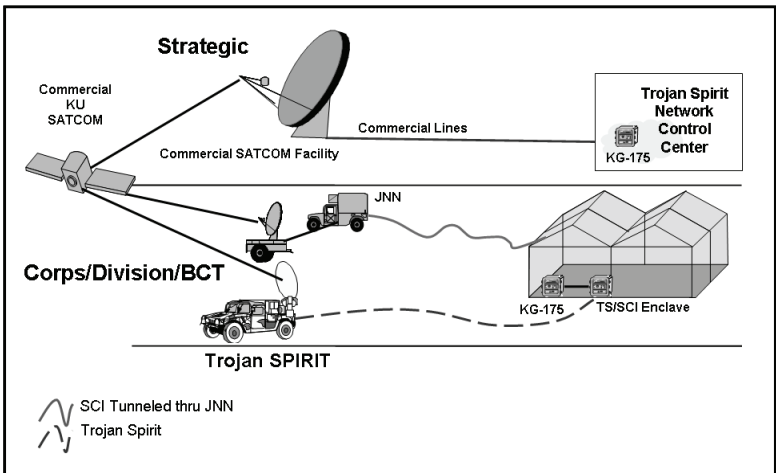

Figure 6-2. Trojan SPIRIT architecture

MEDICAL COMMUNICATIONS FOR COMBAT CASUALTY CARE

6-10. The MC4 together with the Theater Medical Information Program provides near real time medical information for the medical community in a tactical environment. This family of systems supports C2, situational understanding, and commodity management by seamlessly linking, both vertically and horizontally, all echelons of medical care and logistics.

6-11. The MC4 provides the following capabilities and functions—

- Electronic medical record.
- Medical surveillance.
- Patient accountability.
- Medical regulating.
- Medical reference.
- Medical logistics.
- Reporting and security.

MEDICAL SURVEILLANCE AND ELECTRONIC MEDICAL RECORD

6-12. Armed Forces Health Longitudinal Technology Application (AHLTA)-Mobile (formerly known as Battlefield Medical Information System Tactical-Joint) operates on a hand-held device enabling medics in the field to record initial patient encounter data and synchronize it with the AHLTA-Tactical (formerly Combat Health Care System II-Tactical) application. AHLTA-Mobile is an application used on a point-of-care hand-held assistant that records, stores, retrieves, and transmits the essential elements of patient encounters in an operational setting.

6-13. This information is synchronized and the data transmitted to a server for surveillance, analysis, storage, and retrieval purposes. Reference materials, diagnostic and treatment decision aids, and logistic support software can also be included to facilitate patient care,

MOS skill training, and mission planning. It can act as a stand-alone system or can transmit medical data to servers providing data for readiness, medical history, consultation, evacuation, and other medical planning and force health surveillance operations.

6-14. Joint medical workstation and theater medical data store are Web-based applications accessible via the MC4 system. Joint medical workstation is a medical surveillance tool on a classified network allowing unit commanders access to a summary of multiple reports for enhanced medical SA. It offers users the ability to view individual patient encounters anywhere in the world.

6-15. Providers can view stored medical data on the Soldier regardless of where it was input. Patient encounters in theater are entered through the MC4 laptop with AHLTA-Tactical to the theater medical data store server, where the records can be accessed via joint medical workstation (SIPRNET) and theater medical data store (NIPRNET). The records are also transferred to the Central Database Repository as part of the Soldier's life-long medical record.

PATIENT ACCOUNTABILITY

6-16. Patient Accounting and Reporting Real-Time Tracking System is an application that offers casualty location and medical condition information to authorized users instantly via the Battle Command Network.

6-17. Joint Patient Tracking Application is a patient tracking application that receives medical information from MC4 via theater medical data store. This allows Army commanders to track their wounded Soldiers, by name, throughout the CONUS and OCONUS.

MEDICAL LOGISTICS

6-18. Theater Army Medical Management Information System customers assistance module and the defense medical logistics standard support customer assistance module are applications that interface to the Theater Army Medical Management Information System medical

logistics inventory program that provides additional medical logistics capabilities, including inventory access and medical equipment (Class VIII) ordering between levels of care.

REPORTING, COMMUNICATIONS, AND SECURITY

6-19. Theater Medical Information Program is an application that provides the security and communications path for the data transfer from AHLTA-Tactical and AHLTA-mobile to the theater medical data store and joint medical workstation servers. Theater Medical Information Program reports provide query capabilities against the local database. It also provides commanders with SA information and patient visibility, along with support for pre-defined status reporting and epidemiology monitoring.

PUBLIC AFFAIRS OFFICE DIGITAL VIDEO AND IMAGERY DISTRIBUTION SYSTEM

6-20. Public Affairs Office Digital Video and Imagery Distribution System (DVIDS) is a state-of-the-art, around-the-clock operation that provides a timely, accurate, and reliable connection between the media around the world and the military serving in Iraq, Afghanistan, Kuwait, Qatar, and Bahrain.

6-21. Through a network of portable Ku-band satellite transmitters located in-theater and a distribution hub in Atlanta, Georgia, DVIDS makes available real-time, broadcast-quality video, still images, and print products, as well as immediate interview opportunities with service members, commanders, and subject matter experts.

6-22. Using advanced technology and innovative processing DVIDS processes and manages massive amounts of content seamlessly through backend Web applications that manage workflow for all different media types. Built upon the backend of the Encompass Asset Management System, DVIDS processes and distributes (including play out) all digital video, tape-free.

GLOBAL BROADCAST SYSTEM

6-23. The GBS provides a one-way, high-speed, information flow of high volume data and multimedia information such as unmanned aircraft system video, imagery, maps, weather, sustainment, and air tasking orders. GBS uses military satellites augmented by commercial Ku band satellites. The GBS is found at all levels and usually resides within the G-6/S-6 section. However, it is general purpose user-operated and may be assigned to other sections such as the G-2/S-2.

6-24. GBS is a system of broadcast managers, injection points, broadcast satellites, receiver terminals, and management processes for requesting and coordinating the distribution of information products. It supports routine operations, training and military exercises, special activities, crisis, SA, weapons targeting, intelligence, and the transition to and conduct of opposed operations short of nuclear war.

6-25. GBS provides joint operations with high speed, multimedia communications and information flow for deployed, on the move (in-transit), or garrisoned forces. Homeland defensive operations are supported by a requirement for CONUS coverage, which also provides exercise support, training, and workups for deployment. GBS also supports military operations with US allies or multinational forces dependent on security and cryptographic releasability restrictions. Figure 6-3 depicts the system architecture for the GBS.

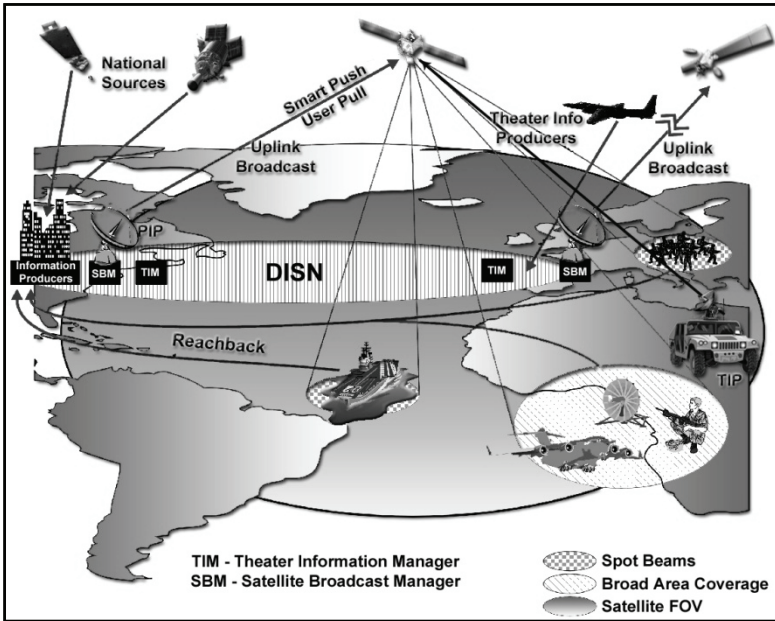

Figure 6-3. GBS architecture

6-26. Today's DOD needs large volumes of information delivered rapidly to deployed, on the move, and garrison users. Many of these information requirements are standard products, such as imagery, intelligence, training, 24-hour commercial news, various tactical video (for example, unmanned aircraft system video, commander's tactical briefing, etc.), weather services, and other desired broadcast services. Other unique information products are tailored for an operating area, such as local weather products, environmental sensing updates, theater intelligence reports, airborne reconnaissance video, air tasking orders, Tomahawk mission data updates, SA updates, and theater-generated mapping and imagery composites. GBS uses current digital satellite broadcasting technology to disseminate these information products to the GBS users.

6-27. High data rate satellite terminals are characteristically large and fixed, but GBS receive terminals are small, mobile, and receive high-volume data using 1-meter or smaller antennas. Mobile force elements, free from restrictive large fixed terminals, can receive information formerly available only to command centers. Current GBS technology supports data rates between 1.544 and 45 Mbps depending on satellite capability, but transmits at lower data rates to support disadvantaged users or to compensate for environmental conditions. Each satellite that supports the GBS will be served by a satellite broadcast manager and a primary injection point (PIP) or a theater injection point (TIP). The GBS relies on DISN connectivity to relay information from national and theater information sources to the satellite broadcast manager for broadcast injection via a PIP.

6-28. The GBS TIP will be available under selected theater tactical brigades that are equipped and structured to install, operate, and maintain it. The GBS TIP enables in-theater forces to transmit information via the GBS as opposed to being able only to receive information transmitted by the PIPs.

BROADCAST MANAGEMENT SEGMENT

6-29. A fundamental feature of GBS is the broadcast management segment which retrieves, accepts, coordinates, and (if required) packages information such as general broadcast products, “Smart Push” products, and “User Pull” products. The required information is gathered from both national and theater sources for broadcast based on the direction and priorities identified by their respective combatant commanders and their functional users.

6-30. The broadcast management segment also performs any additional functions necessary to support the efficient use of GBS. These functions include, but are not limited to, managing space segment coverage and capacity sharing, providing interface protocols and standards designed to allow information providers to submit information in a form acceptable by the GBS broadcast, and coordinating with the combatant commander information manager cells

to apply combatant commander's priorities. Within the maneuver force, the GBS is a user-owned and -operated system that provides a high bandwidth data broadcast capability to multiple users in the AO.

TRANSMIT SEGMENT

6-31. The transmit segment consists of two satellite broadcast manager facilities; three fixed PIPs, and deployable TIPs. The high data rate bit stream is transmitted from one of the fixed or deployable injection points, as directed by the combatant commanders, and managed by the broadcast management segment in each satellite field of view. The information being transmitted is received by a myriad of GBS receiver systems. At the direction of the combatant commander theater information manager, the satellite broadcast manager collects data files and digital video from national, DOD, and inter- and intra-theater information sources; constructs a broadcast stream; and transmits the signal to the GBS transponders on the UHF follow-on satellite.

SPACE SEGMENT

6-32. The GBS space segment is supported by two UHF follow-on satellites. There are four Ka-band transponders hosted on each of these UHF follow-on satellites dedicated to GBS applications. Each satellite also has one steerable patch array antenna that can be moved to the appropriate location to support broadcast from a TIP.

6-33. Each of the UHF follow-on satellites has three GBS dedicated steerable downlink antennas for broadcast within that satellite's geographic field of view. Information fed to the satellite can be routed from the four transponders to the three downlink beams as deemed appropriate by the combatant commander based on user dispersion and operational necessity. All components of the GBS architecture are designed for interoperability with the wideband global satellites as they become available. The GBS is compatible with commercial Ku-band satellites that are used to provide broadcast coverage outside the UHF follow-on/GBS field of view (CONUS) or as needed for augmentation

for the UHF follow-on/wideband global satellite constellations depending upon unit dispersion and information requirements in specific geographical areas.

GROUND RECEIVE SEGMENT

6-34. GBS receive suites receive, process, and disseminate GBS broadcast content to end-users over backend communications networks. Receive suites consist of a receiver/transmitter and receive broadcast manager. The receiver/transmitter consists of an antenna group that includes a dish antenna, a low noise block down converter, satellite tracking hardware and software, and associated interface cabling and equipment.

6-35. The receive broadcast manager consists primarily of the integrated receiver decoder assembly, one or more computer systems with receive broadcast manager software installed, a cryptographic unit, and associated hardware including splitters, cabling, and switches.

6-36. Receive suites are designed around an open architecture and may be configured based on the demands of the individual user. Receive suites can be either transportable or fixed ground receive suites (refer to Figure 6-4). There may be variations of these receive suites for airborne, portable, and mobile applications in the future.

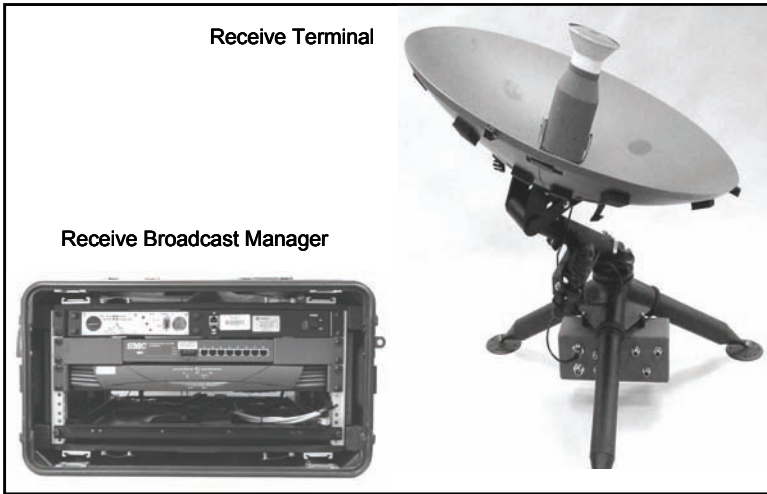

Figure 6-4. Transportable ground receive suite

GBS MISSION REQUEST

6-37. Units must articulate requirements via submission of a GBS mission request prior to deployment and update the request as mission needs dictate changes in types of information products, time and pace of initial delivery/updates, and modification of delivery times or unit locations. It is critical that GBS mission requests are tailored to support specific unit missions and that the G-6/information management officer/knowledge management officer collects staff information requirements and identifies the location of associated national source repositories.

6-38. The information management officer/knowledge management officer can access the satellite broadcast manager product catalog via SIPRNET to select those products already available from the satellite broadcast manager and include them in the GBS mission request submission.

6-39. For those products not already available on the personal computer, units must provide specific location information on the GBS mission request to facilitate the satellite broadcast manager's ability to acquire the information and prepare it for broadcast IAW the unit established timelines and priorities. Pre-deployment network integration is recommended to confirm GBS mission request effectiveness and network integration, and identify any GBS mission request changes that are required.

G-6/S-6 Officer and GBS

6-40. The G-6/S-6 officer is responsible for planning and integration of all peripheral devices (for example, LAN, WAN, computer hardware, monitors, etc.) needed to make information available to the end user. The G-6/S-6 officer is also responsible for processing user-addressed information in the manner that best suits his needs.

6-41. Matching staff needs with available products is challenging. The G-6/S-6 officer must identify each staff section's information needs and select those that are best satisfied by the GBS dissemination architecture. This is based on type, size, criticality of priority, and information repository location. Those that are deemed appropriate for GBS delivery is included on the GBS mission request submission.

TELEENGINEERING OPERATIONS CENTER

6-42. The TeleEngineering Operations Center provides deployed DOD personnel the worldwide capability to talk directly with experts in the United States when a problem in the field needs quick resolution. Deployed troops can be linked to subject matter experts within the Corps of Engineers, private industry, and academia to obtain detailed analysis of complex problems that would be difficult to achieve with the limited expertise or computational capabilities available in the field.

6-43. TeleEngineering Operations Center staff members respond to incoming information requests and provide detailed analyses of problems, such as flooding potential due to dam breaches, load carrying capacities of roads and bridges, field fortifications, and evaluation of transportation networks.

TELEENGINEERING COMMUNICATIONS EQUIPMENT

6-44. TeleEngineering communications equipment provides video teleconferences and data transfers that can be conducted from remote sites where other means of communications are nonexistent or unavailable.

6-45. The TeleEngineering toolkit is a software product that provides a valuable analysis tool to personnel on the ground or going into an area of operation. By annotating an area of interest, a small reference file can be sent back to the subject matter experts to provide requests for a variety of information, including cross-country mobility analysis, flood analysis, and vegetation information. The response can then be sent back and graphically displayed using the TeleEngineering toolkit.

6-46. The automated route reconnaissance kit combines the power of the TeleEngineering toolkit with a global positioning system, video camera, and three-dimensional accelerometers to provide automated route reconnaissance.

STANDARDIZED INTEGRATED COMMAND POST SYSTEM

6-47. The Standardized Integrated Command Post System (SICPS) provides modular, interoperable, and fully integrated command post platforms and information and communications physical infrastructure with joint capabilities to commanders and staffs. SICPS integrates ABCS systems, intercoms, large-scale video displays, and LANs into standard Army command post shelters and tents.

6-48. SICPS is primarily a non-developmental effort that integrates state-of-the-art government off-the-shelf and COTS equipment into tactically mobile/deployable platforms that support the operational needs of the current force and the Stryker BCT force, and has direct applicability to the Future Force. SICPS consists of three major subsystems: the SICPS command post platform, the SICPS family of tents with trailer-mounted support systems, and the command center system.

6-49. The SICPS family of tents with trailer-mounted support systems is a series of quickly erected tents, power generation and environmental control units that will provide the command post with environmentally controlled workspace, power distribution, lighting, tables, integrated flooring, a cable management system, and a common grounding system. A large-scale display and its associated video controller that make up the command center system supports enhanced collaborative staff functions.

6-50. SICPS and its integrated infrastructure are the critical enablers that support the capability needed to fully realize shared situational understanding, for example, common operational picture, inherent in the various Army and joint C2 communications and network systems that enable network centric C2. SICPS also serves as an enabler for approved battle command systems by hosting the ABCS information service server associated with the ABCS (V) 6.4 architecture, as well as other servers such as the command post of the future (CPOF) server and servers associated with Global Command and Control System-Army (GCCS-A).

This page intentionally left blank.

Appendix A

Electromagnetic Spectrum Management Operations

Radio frequency spectrum is the range of electromagnetic frequencies used in the transmission of voice, data, and video. It is a shared resource that is non-expendable and finite. A limited number of channels or frequencies can be accommodated at any time in an AO. This appendix provides an understanding of spectrum management and addresses the roles of the spectrum manager. (For more information on EMSO, refer to FMI 6-02.70.)

THE ELECTROMAGNETIC SPECTRUM

A-1. Electromagnetic spectrum is defined as the entire range of radiated energy from low frequency (LF) radio waves through visible light radiation and further to gamma and cosmic rays. Figure A-1 below depicts the full range of the electromagnetic spectrum. To enable network centric warfare, the Army must have access to the radio frequency portion of the spectrum, which is generally considered the high frequency to EHF range of frequencies.

Appendix A

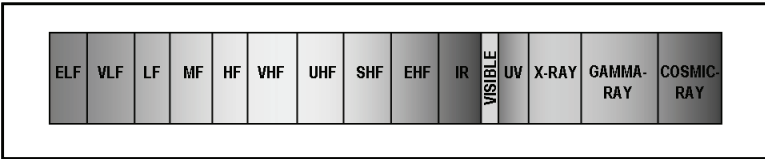

Figure A-1. The electromagnetic spectrum

A-2. The Army does not own any spectrum in the United States or in any foreign country. In the United States, the Army shares government allocated spectrum with federal agencies and other military services. For example, of the 2320 frequencies a SINCGARS radio can use, only 200 of these are available for government use while the rest are shared or borrowed from the Federal Communications Commission.

A-3. The spectrum is a sovereign resource that each country controls and regulates to satisfy economic and security needs, as necessary. While there are some international bands for radio services, countries parcel the electromagnetic spectrum to meet their individual needs. For example, radio frequency systems designed to operate in one geographic area or country, or the United States may not be able to legally operate in other geographic areas such as Europe.

ELECTROMAGNETIC SPECTRUM OPERATIONS

A-4. EMSO incorporates spectrum management, frequency assignments, policy implementation, and host nation coordination that enables the efficient use of the electromagnetic spectrum for combat operations. EMSO enables and supports all spectrum dependent emitters to include wireless extensions of networked communications systems, all domains of electronic warfare, and many other information management systems that support EMSO consists of planning, operating, and coordinating joint use of the electromagnetic spectrum through operational, engineering, administrative, and policy implementation procedures. The objective of EMSO is to enable electronic systems that rely on wireless connectivity to perform their

Electromagnetic Spectrum Management Operations

functions in the intended environment without causing or suffering unacceptable frequency interference.

A-5. The primary focus of spectrum management is to obtain a valid frequency license from the controlling authority at the international, national, host nation, unified command, multinational, or military department level agencies to operate equipment on a certain specified frequency.

A-6. The Army spectrum management process includes the application of operational, engineering, and administrative procedures to allotted radio frequency bands to maximize reuse and sharing of the spectrum that is available. It enables electronic equipment to perform their functions in their intended environment using electromagnetic compatibility measures, without suffering degradation from or causing unacceptable degradation to other equipment.

A-7. It centers on managing discrete frequencies or frequency bands using frequency allotments and frequency assignments; assuring compliance with local radio regulatory policy, rules, and procedures; application of sound electromagnetic compatibility measure practices; resolution of harmful interference at the lowest operational level possible; and timely reporting of incidents of harmful interference that cannot be resolved locally. Figure A-2 illustrates the Army spectrum management process.

TACTICAL SPECTRUM MANAGEMENT

A-8. Spectrum management is bottom driven for requirements and top fed for resources. The division and BCTs represent the “pointy end of the spear,” and it is critical that all requirements are captured by the G-6/S-6 at each echelon to ensure the commander receives the proper resources.

Appendix A

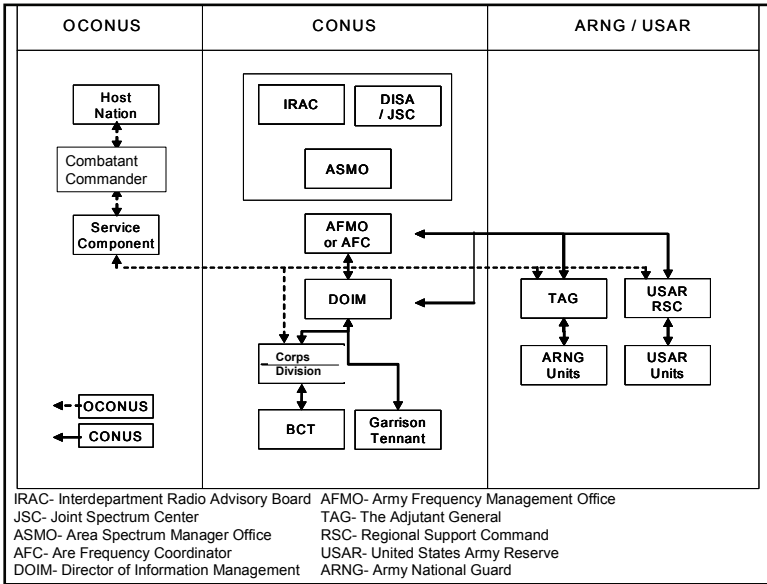

Figure A-2. Army spectrum management process

A-9. In the past, the bulk of spectrum management was concerned with communications emitters for the backbone and CNR networks. Today’s operational environment presents many unique spectrum challenges. Figure A-3 shows that, while communications is certainly a spectrum management concern, there are many other competing systems for spectrum. It is the G-6/S-6 responsibility to coordinate with all spectrum users in the AO to ensure all requirements for spectrum access are identified. A list of all radio frequency emitters in the AO must be maintained by the G-6/S-6 to ensure that competing systems for the same portion of spectrum can be identified and prioritized for frequency assignments.

Electromagnetic Spectrum Management Operations

A-10. The geographical combatant commander is the controlling authority for spectrum. The geographical combatant commander normally provides subordinate units, as an allotment, a pool of frequencies to be used by certain equipment in certain geographical locations on a first come first serve basis.

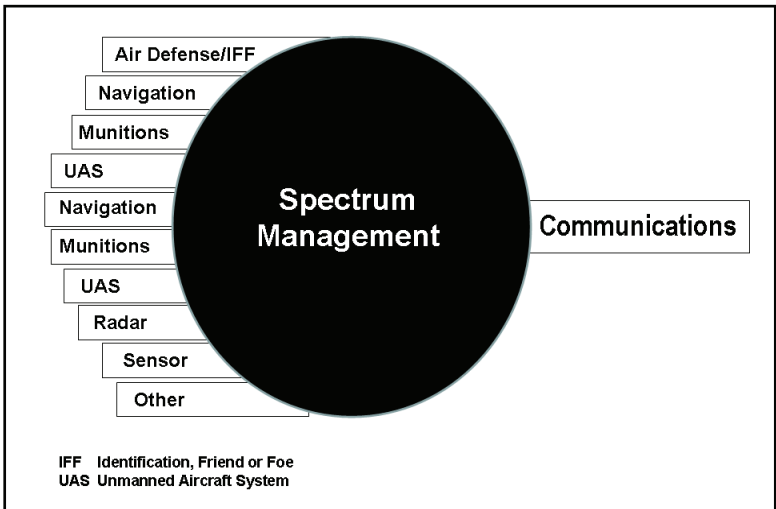

Figure A-3. Spectrum management radio frequency systems

TACTICAL SPECTRUM MANAGEMENT OPERATIONS PROCESS

A-11. The role of the spectrum manager is to gather, adjudicate, and forward requirements for all spectrum support for the division to the next higher authority.

Appendix A

A-12. During day-to-day operations/training at home station, the G-6 spectrum manager normally uses Spectrum XXI to maintain and update resident frequency records and requests. The automated communications engineering software (ACES) builds and publishes the CEOI, and a network-planning tool such as ISYSCON or detailed planning and engineering module engineers frequencies for LOS networks. Table A-1 describes these tools.

Table A-1. Spectrum management tools and descriptions

System	Description
ACES	The ACES is a net planning software program for the US Army. ACES works in a ruggedized Windows NT COTS platform for tactical operations and in desktop Windows NT workstations in strategic locations. ACES allows military users to perform fully automated cryptonet, signal operating instructions, CEOI, joint CEOI, and electronic protection planning, management, validation, and generation distribution at the time and location of need. The Military Communications Electronics Board has designated ACES as the Joint Spectrum Management Planning software (called Joint Automated Communications-Electronics Operating System [JACS]) for multiservice operations.
JACS	JACS has the same basic function as ACES. JACS's core purpose is to allow an interface between the joint CEOI generation tool with service unique communications planning software and spectrum management automated tools.
Joint Network Management System	The Joint Network Management System is used at joint level to integrate network management functions. The spectrum management portion uses existent systems (Spectrum XXI/JACS/ACES), and while providing some level of integration, it essentially adds no new capabilities to the spectrum management process.
ISYSCON, DPEM, and NPT	The ISYSCON, detailed planning and engineering module, and network planning terminal are used primarily to engineer the Army LOS communications network for division and below.

Electromagnetic Spectrum Management Operations

Spectrum XXI	<p>Spectrum XXI is the spectrum management tool designated by the Military Communications Electronics Board as the joint DOD spectrum management standard. It is used to create, modify, renew, and delete permanent/temporary frequency assignments/proposals worldwide.</p>
	<p>The Spectrum XXI software was developed under the management and direction of the DOD Joint Spectrum Center and the National Telecommunications and Information Administration. Spectrum XXI was developed to automate many processes and standardize the spectrum management process throughout the federal government.</p>
	<p>Spectrum XXI is not a program of record and therefore did not follow the traditional acquisition process. Spectrum XXI was designed as a tool for combatant commanders and consequently is not agile enough to support maneuver operations. It is, however, the only tool available at this time to assist in spectrum management. Spectrum XXI can be used in either a stand-alone mode or connected to regional servers via the SIPRNET; however, the client server relationship is not automatic. The clients must initiate a data exchange to update both the server and the client's machine. In addition, equipment such as satellites and radars are many times, not accounted for which creates inaccuracies in the electromagnetic picture. Spectrum XXI also has no visibility of real time operations and is reliant on the operator to update the database to maintain accuracy, which in a highly dynamic operational environment is unlikely.</p>

A-13. During mobilization, spectrum managers are involved in all planning meetings to determine what frequency requirements will be based on the division structure (which and how many types of brigades will be in the division). Once the initial requirements are determined, the spectrum managers will begin building the master net list, initiate frequency requests, and begin coordination of electronic warfare issues.

Appendix A

A-14. Once the frequency allotment has been received and the network plans are finalized, the CEOI is built and published, and distribution of frequencies to other equipment such as unmanned aircraft systems, munitions, radars, etc., will be accomplished.

Note. There is currently no spectrum management tool that allows for en route planning. Only manual adjustments can be made to any plans.

A-15. In the AO, any adjustments to the spectrum management plan are made by exception due to Spectrum XXI, ACES/JACS, and ISYSCON/Joint Network Management System being static planning tools that do not support maneuver operations.

A-16. During operations, the spectrum manager will constantly be resolving frequency deconfliction issues and participating in electronic warfare planning. Depending on the type of operations, the spectrum manager may also be negotiating with host nations, non-governmental organizations, or joint, interagency and multinational organizations for spectrum support and/or deconfliction.

A-17. A unique challenge facing spectrum managers today is the use of the spectrum by the enemy to detonate improvised explosive devices. It is possible to mitigate the danger by jamming specific frequency bands; however, this also denies use of these bands for operational use. The spectrum manager must work closely with the appropriate staff sections in order to best support the commander's intent and the mission.

Stability Operations

A-18. Spectrum managers should refine and update their plans to keep the database as accurate as possible. As units rotate or leave the AO, diligent database maintenance is required to accurately reflect assignments to efficiently use the electromagnetic spectrum. The spectrum manager ensures that spectrum remains available for key

Electromagnetic Spectrum Management Operations

military systems while at the same time negotiating for commercial spectrum for post, camp, or station operations such as the land mobile radio or security systems.

A-19. The spectrum manager must work closely with the G-2/S-2 and G-3/S-3 to coordinate electronic warfare planning and execution including publication of the Joint Restricted Frequency List. Once the resources have been allotted, the spectrum manager will assign frequencies to all emitters in the AO to include those for the network.

A-20. The spectrum manager will work with the appropriate network manager to assist in the frequency engineering of the network (for example, LOS radio shots and building and publishing the division CEOI). Due to the scarcity of spectrum in certain situations, it may be necessary for the G-6/S-6 to make recommendations to the commander concerning the prioritization of spectrum assignments.

Sustainment Training

A-21. The skills associated with spectrum management software are highly perishable. The G-6/S-6 must secure access to the SIPRNET for the spectrum manager to properly operate Spectrum XXI for training and operational exercises. Failure to have access to the SIPRNET will limit the use of Spectrum XXI as a stand-alone client and hinder its effectiveness as the spectrum manager's primary tool.

Note. The G-6/S-6 must ensure regular training and use of the software to maintain proficiency.

SPECTRUM VIOLATION

A-22. It is critical that all levels of command understand the inherent risk of violating the rules of proper spectrum management. In many cases, a radio signal is all that connects a Soldier, platoon, or company to safety by providing SA or available support. In the past, bootlegging a frequency only affected the communications network. However,

Appendix A

today that practice can have first order, and in many cases, second and third order effects that are undesirable on other systems.

A-23. Emitters that are turned on in a geographic AO without the proper clearance and certification have the same affect as bootlegging a frequency. Some of the effects of these actions have included the crashing of a multi-million dollar unmanned aircraft system and lack of communications between elements during critical situations.

Appendix B

Army Battle Command System

The ABCS (V) 6.4 is a core set of common support software that is commonly run on a CHS, a specialized workstation, or a COTS laptop. These integrated information systems allow commanders and their staff access to real or near-real time information in the full spectrum of military operations. This appendix describes the key fielded and developmental information systems available to forces under the ABCS.

ABCS INTRODUCTION

B-1. ABCS is a collection of information systems that provides commanders and staffs with SA, situational understanding, and the capability to exchange necessary information across echelons and warfighting functions during full spectrum operations. Each system plays a critical part in planning, preparing for, executing and assessing operations. ABCS automates the combat business process during the prosecution of well known and rehearsed staff battle drills. These battle drills and systems provide TOCs the ability to analyze, coordinate, direct, and synchronize combat operations during maneuver operations. The Battle Command Common Services platform employs a publish-and-subscribe data dissemination service to enable the exchange of information between different systems, as well as business enterprise services to enable dissemination of knowledge beyond the boundaries

Appendix B

of ABCS clients. The following paragraphs describe the systems that comprise ABCS and Figure B-1 depicts the ABCS.

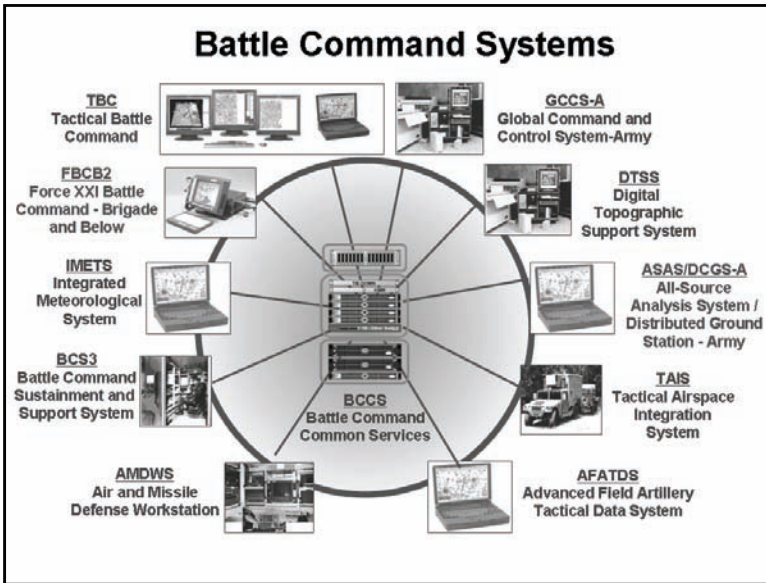

Figure B-1. The Army battle command system

TACTICAL BATTLE COMMAND

B-2. Tactical Battle Command consists of the Maneuver Control System and CPOF.

Maneuver Control System

B-3. The Maneuver Control System allows commanders and staffs to visualize the operational environment and synchronize the elements of combat power for successful execution of combat operations. The Maneuver Control System also serves as the primary system to integrate and manage data from supporting ABCS systems onto a

single map display to create a user-defined common operating picture. It provides the planning tools to support and manage deliberate mission planning and to produce and disseminate orders. It also provides Army engineer and joint chemical, biological, radiological and nuclear tools to support planning, execution and management of engineer and chemical, biological, radiological and nuclear missions and tasks.

Command Post of the Future

B-4. CPOF) is a decision support system that provides SA and collaborative tools to key leaders and staff. CPOF integrates information from the ABCS and other systems to provide a continuous and near real-time common operating picture to the commander and staff to enable map-centric visualization of planning and significant operational activities.

GLOBAL COMMAND AND CONTROL SYSTEM-ARMY

B-5. The GCCS-A provides the link for the ABCS to the Global Command and Control System. The GCCS-A provides a common operating picture and associated friendly and enemy status information and provides force employment planning and execution tools. These include receipt of forces, intra-theater planning, readiness, force tracking, onward movement, and execution status. GCCS-A is not ordinarily found below division level.

ALL SOURCE ANALYSIS SYSTEM/DISTRIBUTED COMMON GROUND SYSTEM-ARMY

B-6. The All Source Analysis System (ASAS) is an intelligence fusion system that provides a timely, accurate, and relevant picture of the enemy situation. It provides graphic representations of the enemy situation to ABCS and provides all source intelligence to support development of the common operating picture. It also supports

Appendix B

management of intelligence, surveillance assets, intelligence collection, provision of electronic warfare support, and the protection warfighting function. The All Source Analysis System interoperates with organic intelligence and electronic warfare sensors; joint, theater, and national sensors; and preprocessors as well as other services' intelligence processors.

B-7. ASAS will be replaced by the Distributed Common Ground System-Army (DCGS-A). DCGS-A provides distributed intelligence, surveillance, and reconnaissance information to Army and Joint and multinational forces. DCGS-A is used to perform planning, management, control and tasking (for some sensors), processing, displaying, and dissemination functions, providing a robust interoperability capability. It will empower the commanders, decision makers, and analysts with intelligence, surveillance, and reconnaissance information and fused products at all echelons.

B-8. DCGS-A will deliver state-of-the-art imagery intelligence, signals intelligence, measurement and signatures intelligence, human intelligence, all source, and fusion capabilities. DCGS-A enables commanders to achieve situational understanding by leveraging multiple sources of data, information, and intelligence.

BATTLE COMMAND SUSTAINMENT SUPPORT SYSTEM

B-9. The Battle Command Sustainment Support System is the maneuver sustainment C2 system that provides a concise picture of unit sustainment requirements and support capabilities. It connects and supports the logistician by integrating the logistics common picture and in-transit visibility, enabling the view of material in the logistics pipeline. It exchanges information with ABCS and joint systems.

AIR AND MISSILE DEFENSE PLANNING AND CONTROL SYSTEM

B-10. The Air and Missile Defense Workstation is the C2 component of the Air and Missile Defense Planning and Control System. It is a digitized tool for monitoring and managing air and missile defense plan with the ground scheme of maneuver. It is used to integrate sensors, air defense fire units, and CPs from the air defense artillery battery through theater echelons. The Air and Missile Defense Workstation is used to display air and missile defense plans and air SA to ABCS and commanders at all echelons.

ADVANCED FIELD ARTILLERY TACTICAL DATA SYSTEM

B-11. The Advanced Field Artillery Tactical Data System is a fire support planning, coordinating, and controlling system that provides for counter-fire, interdiction, and suppression of enemy targets. It provides integrated support for all fire support assets including field artillery, mortars, close air support, naval gunfire, and attack helicopter. The Advanced Field Artillery Tactical Data System displays fire support systems, target types, command guidance, available munitions, and weapons status so that informed decisions may be made based on the commander's guidance.

FORCE XXI BATTLE COMMAND, BRIGADE AND BELOW

B-12. FBCB2 provides increased SA to the commander by depicting an accurate and automatic view of friendly force, enemy forces, obstacles, and known battlefield hazards. FBCB2 supports OPCON through the transmission and receipt of orders, reports, and data. FBCB2 uses two forms of communications means: terrestrial and satellite. FBCB2 terrestrial uses EPLRS and, to a lesser extent, SINCGARS to exchange data and provide SA. FBCB2 satellite, known as BFT, shares SA with terrestrial units and ABCS systems that use

Appendix B

reachback tunnels found in regional operation centers. Terrestrial- and satellite-based FBCB2s are interoperable and allow the exchange of SA between them. Approximately 70 percent of the forces employ BFT with terrestrial-based FBCB2 used by 30 percent of the forces.

B-13. FBCB2 is a mission essential sub-element and a key component of ABCS. It is also interoperable with the maneuver control system, ASAS, Advanced Field Artillery Tactical Data System, air and missile defense workstation, and Battle Command Sustainment Support System. FBCB2 will feed the ABCS common database with automated positional friendly information and current tactical battlefield geometry for friendly and known/suspected enemy forces. Common hardware and software design will facilitate training and SOP.

TACTICAL AIRSPACE INTEGRATION SYSTEM

B-14. The Tactical Airspace Integration System (TAIS) is a digitized, integrated, and automated system that provides Army airspace C2 and air traffic services. The TAIS links the air defense and airspace management cell to the joint force air component commander's theater battle management core systems for Army airspace integration into the joint fight. The TAIS also interfaces with civil airspace control agencies and provides input to ABCS.

DIGITAL TOPOGRAPHIC SUPPORT SYSTEM

B-15. The Digital Topographic Support System provides automated support for terrain mapping and analysis, and creation of topographic products. It provides on screen and hard copy terrain analysis products that include on and off road mobility maps, concealment maps, on road choke point maps, and tactical fording/bridging maps. The Digital Topographic Support System is ordinarily found at the corps through brigade level. Digital Topographic Support System geospatial and topographic capabilities will be provided as a capability within DCGS-A when it is fielded.

INTEGRATED METEOROLOGICAL SYSTEM

B-16. The Integrated Meteorological System provides an automated weather system to receive, process, and disseminate weather observations, forecasts, and weather and environmental effects decision aids from the corps through brigade level. The Integrated Meteorological System processes and collates forecasts, observations, and climatological data to produce timely and accurate weather products tailored to the commander's needs. It is able to analyze and graphically display the impact of current and projected weather conditions on friendly and enemy capabilities. Integrated Meteorological System weather capabilities will be provided as a capability within DCGS-A when it is fielded.

ISYSCON (V)4, TACTICAL INTERNET MANAGEMENT SYSTEM

B-17. The ISYSCON (V)4 provides the tactical Army commander, G-6/S-6 officer, and signal staff an automated system to support LANs and CNR-based WANs. CNR consists of EPLRS, wideband networking waveform radios, SINCGARS, and SATCOM. Specifically, the ISYSCON (V)4 will support initialization and management of critical information devices. The ISYSCON (V)4 will support information operations and automation in support of combat forces, their weapon systems, and the other related automated systems. The ISYSCON (V)4 will provide LAN management services for LANs at all echelons from theater through maneuver battalions. LAN management includes the planning, configuring, and fault management for all network devices located on each LAN.

BATTLE COMMAND COMMON SERVICES

B-18. The Battle Command Common Services platform is a collection of server hardware and software application that provides the core ABCS interoperability services and the infrastructure necessary to

Appendix B

employ enterprise-class services and an objective service-oriented architecture. BCCS provides TOCs at multiple echelons a localized network directory, access control and other services to an expanding array of ABCS and non-ABCS systems (collaboration servers, databases, file servers, websites, email, etc.) and networks that are operated either in a standalone configuration or as part of the GIG.

Appendix C

Signal Military Occupational Specialties

As the Army transforms to a modular force, our deployed forces become more dependent on information passed over the network. Signal communications Soldiers and information systems Soldiers must provide the communication services required to accomplish the mission. This appendix provides an overview of the signal enlisted and officer branches MOSs.

ENLISTED MILITARY OCCUPATIONAL SPECIALTIES

C-1. The enlisted signal MOS (25 career management field) covers a vast area of communications equipment. Depending on the MOS, enlisted signal Soldiers are trained to install, operate, and maintain strategic and tactical communications and information equipment. Signal Soldiers can train and work on equipment such as—

- Digital group multiplexer.
- COTS equipment (for example, IP routers, PROMINA switches).
- Tri/Quad band SATCOM.
- WIN-T.
- High capacity LOS.

Appendix C

- Tactical radios (for example, AN/PRC-150, Joint Tactical Radio System, SINCGARS, and multiband inter/intra team radio).
- FBCB2 and EPLRS.

SIGNAL REGIMENT OFFICER AREA OF CONCENTRATION

C-2. The Signal Corps is a basic branch of the Army. Signal officers lead Soldiers and units that provide and manage communications and information systems support for the C2 of combined arms forces. Signal support includes NETOPS, IA, information dissemination management, network management, and management of the electromagnetic spectrum. Signal support encompasses all aspects of designing, installing, maintaining, and managing information networks to include communications links, computers, and other components of LANs and WANs.

C-3. Signal support also includes the integration of user-owned and –operated systems into the networks. Signal forces plan, install, operate, and maintain voice and data communications networks that employ single and multi-channel satellite, TROPO, terrestrial microwave, switching, messaging, video-teleconferencing, visual information, and other related systems. They integrate tactical, strategic, and sustaining base communications and information processing and management systems into a seamless global information network that supports knowledge dominance for Army, joint, and multinational operations.

SIGNAL WARRANT OFFICERS

C-4. Signal warrant officers are adaptive technical experts, leaders, trainers, and advisors who provide technical leadership and advice in planning and directing NETOPS communications, and IA at all levels of command from sustaining military bases to forward-deployed fighting forces in support of Army, joint, combined, and multinational operations worldwide. Signal warrant officer MOSs include 255Z Senior Signal Systems Technician; 250N Network Operations Technician; 251A Information Systems Technician; and 254A Signal

Signal Military Occupational Specialties

Systems Support Technician. DA PAM 600-3 contains a comprehensive professional development guide for signal warrant officers.

Note. DA PAM 611-21 contains a comprehensive guide to all MOSs, to include areas of concentration, duty descriptions (by grade), and standards of grade tables. DA PAM 611-21 can be accessed through the US Army Human Resources Command Web site at <https://perscomnd04.army.mil/mosmartbk.nsf>, which is updated with current changes (refer to Figure C-1 for an example of the Web site page).



U.S. ARMY HUMAN RESOURCES COMMAND						
SMARTBOOK						
DA PAM 611-21						
- Chapters -						
HRC Home	Chapter	Title	Specialty	Type	Year-Month	This week's postings
↓	Title	Posted ↓	File Name			File Size
▶	Chapter 01 - Introduction					
▶	Chapter 02 - Officer Classification System					
▶	Chapter 03 - Officer Specifications for Branches/FA					
▶	Chapter 04 - Officer Skill Identifiers					
▶	Chapter 05 - Grade Standards for Officer Positions					
▶	Chapter 06 - Warrant Officer Military Occupational Specialty System					
▶	Chapter 07 - Warrant Officer Reporting Codes					
▶	Chapter 08 - Warrant Officer Qualifications for and Duties of Specific Military Occupations					
▶	Chapter 09 - Enlisted Classification System					
▶	Chapter 10 - Enlisted Qualifications for and Duties of Specific Military Occupations					
▶	Chapter 11 - Enlisted Standards of Grade for Specialized Duty Functions					
▶	Chapter 12 - Enlisted Special Qualification Identifiers and Additional Skill Identifiers					
▶	Chapter 13 - Enlisted MOS, SQI and ASI not Available to Women Soldiers					
▶	Chapter 14 - Enlisted Special Reporting Codes and Duty Assignment					

Figure C-1. DA PAM 611-21 Web site page

This page intentionally left blank.

Appendix D

Signal Annex of an OPORD

The signal leader is responsible for paragraph 5 and the signal annex of an OPORD. This appendix has outlines of paragraph 5 and a signal annex of an OPORD.

PARAGRAPH FIVE OF AN OPERATION ORDER

D-1. Figure D-1 outlines two examples of paragraph 5 of an OPORD (command and signal).

Appendix D

<p><u>Outline One</u></p> <p>5. COMMAND AND SIGNAL.</p> <p>a. Command. State the map coordinates for command post locations and at least one future location for each command post. Identify the chain of command if not addressed in unit SOPs.</p> <p>b. Signal. List signal instructions not specified in unit SOPs. Identify the specific signal operating instructions edition in effect, required reports and formats, and times the reports are submitted.</p> <p><u>Outline Two</u></p> <p>5. COMMAND AND SIGNAL.</p> <p>a. Command.</p> <ul style="list-style-type: none">• State the location of key functional area leaders.• Designate a functional area chain of command and succession of command.• Designate a headquarters to control the effort within functional area work lines on an area basis.• List command posts and other C2 facilities and their locations. <p>b. Signal.</p> <ul style="list-style-type: none">• State edition number of SOI in effect. Do not write "current SOI in effect."• Describe the nets to monitor for reports.• Designate critical functional area reporting requirements.
--

Figure D-1. OPORD paragraph 5, command and signal outline

SIGNAL ANNEX FOR AN OPERATION ORDER

D-2. Figure D-2 is an outline of a signal annex of an OPORD.

[Classification]

Include heading if annex distributed separately from base OPLAN/OPORD.
**ANNEX H (COMMAND, CONTROL, COMMUNICATION, and COMPUTER OPERATIONS)
TO OPERATION ORDER NO ## [code name]—[issuing headquarters]**

1. SITUATION.

a. Enemy forces. Refer to annex B, appendix 1-Intelligence estimate. Also provide enemy capability and activity by describing enemy capabilities that may affect communications systems.

b. Friendly forces.

- Primary communications gateways providing connectivity to higher, lower, and adjacent units.
- Critical communications security measures required to counter expected enemy EW capabilities and protect C2 systems.
- External communications assets that augment signal support unit capabilities.

c. Environment. In separate subparagraphs list all critical terrain, weather, and civil considerations that would impact C4 operations. Refer to appropriate annexes as required.

d. Attachments and detachments.

2. MISSION. State the computers and information systems operations mission in support of this operation.

3. EXECUTION.

a. Scheme of signal support operations.

- (1) Describe the concept of signal operations, including primary and back-up systems supporting critical C2 networks.
- (2) Outline the plan for extending C2 systems by each phase of the operation.
- (3) List critical links between tactical and strategic communications systems.
- (4) Identify critical limitations of organic signal support assets. Define limitations of assets from higher headquarters.
- (5) State signal support tasks that all non-signal units must perform to accomplish missions and tasks beyond normal requirements.
- (6) State signal support priorities.

b. Tasks to subordinate units.

- Signal support tasks that maneuver elements must accomplish that the base OPLAN/OPORD does not contain.
- Signal support tasks that signal units supporting maneuver elements are to accomplish only as necessary to ensure unity of effort.

c. Coordinating instructions.

- Critical signal support instructions not already covered in the base OPLAN/OPORD.
- Key times or events critical to information systems and network control procedures.
- Army Battle Command System control procedures.

4. SERVICE SUPPORT.

5. COMMAND AND SIGNAL.

- a. Identify C2 systems control hierarchy for the common user network.
- b. Identify local area network control procedures for network administration and management.
- c. Use appendixes to diagram any changes to standard communications networks.

ACKNOWLEDGE: (if distributed separately from base order).

**[Authenticator's last name]
[Authenticator's rank]**

APPENDIXES:

DISTRIBUTION: (if distributed separately from base order).

Figure D-2. Outline of a signal annex

This page intentionally left blank.

Appendix E

Maintenance

The Army's transformation to a modular structure has posed unique challenges for CE maintenance. The inactivation of corps signal brigades and division signal battalions resulted in the loss of dedicated CE maintenance sections. The corps, division, and brigade signal companies do not contain dedicated CE maintenance entities. The implementation of two level maintenance and the proliferation of COTS signal equipment have changed the way maintenance is performed and the responsibilities of signal Soldier. This appendix describes the required CE maintenance structure that enables two level maintenance policies and to ensure communications and network maintenance.

TWO LEVEL MAINTENANCE

E-1. The Army has transitioned from a four level maintenance structure to a two level maintenance structure: field and sustainment. The elimination of organic maintenance sections within signal units as a part of modularity has combined with the implementation of the two level maintenance policy to produce a unique maintenance environment that presents a significant challenge to signal Soldiers.

FIELD MAINTENANCE

E-2. Field maintenance generally combines the two levels formerly known as organizational and direct support maintenance and focuses on returning a failed system to an operational status. This is accomplished by fault isolation and replacing the failed component assembly or module on the system. These field maintenance capabilities are also known as “replace forward” or “on system” maintenance. The operator/maintainer 25 series signal Soldier performs “on system” maintenance for communications and network systems and devices. MOS 25U performs operator/maintainer level maintenance for systems and devices that were identified as unit level maintenance items under the old four level maintenance construct.

SUSTAINMENT MAINTENANCE

E-3. Sustainment maintenance focuses on repairing broken components and end items “off system” and returning them to the supply system. Military or civilian personnel perform this maintenance at echelons above brigades. These two levels are also referred to as “replace forward and repair rear”. Figure E-1 shows the two level maintenance process flow. The operator/maintainers 25 series signal Soldiers perform “on system” maintenance. MOS 94 series Soldiers will perform “off systems” maintenance for communications and network equipment.

E-4. The uniqueness of the signal equipment and the imperative of maintaining the network, where downtime is measured in minutes does not always support the process flow. The separation between operator and maintainer is blurred and results in the 25 series operator/maintainer performing equipment replacing tasks to maintain the viability of the network. In addition, the proliferation of COTS equipment in newly fielded systems such as the WIN-T Increment 1 suite of equipment has resulted in much of the maintenance and equipment replacement necessitating the employment of civilian field service representatives (CFSRs) to maintain equipment and systems availability.

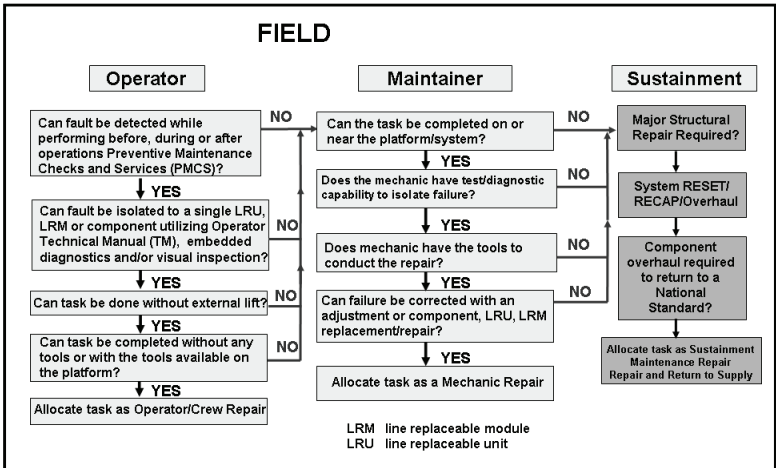

Figure E-1. Two level maintenance process flow

NETWORK SYSTEMS MAINTENANCE

E-5. Army transformation presents challenges for signal leaders and staff requiring greater coordination to ensure success of the network. The challenge centers on the G-6, S-6, and division/brigade signal company leadership. Overcoming the challenge requires working through the organizational boundaries of the respective STB, and brigades to sustain the LWN.

CE MAINTENANCE IN THE MANUEVER BATTALION

E-6. The battalion S-6 is responsible for field level maintenance on battalion CE systems. The S-6 works with the battalion S-4 and supporting forward support company to provide a comprehensive maintenance plan that is incorporated into the unit maintenance SOP. This effort ensures that there are clearly understood procedures in place

Appendix E

to ensure a positive maintenance posture. The S-6 must also coordinate with the S-4 and brigade S-6 for CFSR support as necessary.

E-7. The Army modular transformation and the implementation of the two level maintenance policy moved a 25U, Signal Support Systems Maintainer from the battalion S-6 to the forward support company of the brigade support battalion (BSB). These positions have been moved back to the battalion S-6 sections. The 25U—

- Performs organizational level maintenance on unit communications and electronic systems, remote control systems, intercoms, and information systems. Troubleshoots to a defective LRU/line replaceable module (LRM) unit communications and electronic systems, COMSEC devices, remote control systems, intercoms, and information systems. Replaces and evacuates to the forward support company for repair faulty LRUs/LRMs on communications and electronic systems, and information systems.
- Repairs and installs unit CE systems wiring and cabling.
- Installs and removes all unit vehicular and base station communications, electronics, and information systems. This includes installation kits, antennas, and cables on all platforms.
- Performs communications and electronic systems test using appropriate test, measuring and diagnostic equipment (TMDE).
- Maintains TMDE calibration records.
- Manages and maintains battery inventory and charging systems.
- Orders and maintains bench stock.
- Applies all modification and directions such as technical bulletin guidance.

E-8. Each maneuver battalion is supported by a forward support company from the BSB to perform field level maintenance. The forward support company has a maintenance platoon that repairs automotive, armament, ground support, electronic, and missile equipment. The forward support company focuses on LRUs using combat spares from prescribed load list and shop stock. It has a service and recovery section and performs battle damage assessment and repair. The forward support company's maintenance control section

uses unit level logistics system-ground to order repair parts. The forward support company commander establishes unit maintenance collection points in coordination with the maneuver battalion S-4.

E-9. The SBCT does not contain forward support companies. The BSB will task organize to support the combined arms battalion that make up the SBCT.

CE MAINTENANCE IN THE BRIGADE

E-10. The brigade S-6 is responsible for monitoring the status and sustaining the brigade networks that comprise the LWN. The brigade S-6, working closely with the brigade signal company commander, BSTB staff, and the executive officer, ensures the critical network maintenance and parts needed to remain operational.

E-11. The Army modular transformation and the implementation of the two level maintenance policy moved the 25U, Signal Support Systems Maintainer from the brigade S-6 section to the BSB. These positions have been moved back to the brigade S-6 sections. The 25U—

- Performs organizational level maintenance on unit communications and electronic systems, COMSEC devices, remote control systems, intercoms, and information systems.
- Troubleshoots to a defective LRU/LRM unit communications and electronic systems, remote control systems, intercoms, and information systems.
- Replaces and evacuates to the forward support company for repair faulty LRUs/LRMs on communications and electronic systems, and information systems.
- Repairs and installs unit CE systems wiring and cabling.
- Installs and removes all unit vehicular and base station communications, electronics, and information systems. This includes installation kits, antennas, and cables on all platforms.
- Performs communications and electronic systems test using appropriate TMDE.

Appendix E

- Maintains TMDE calibration records.
- Manages and maintains battery inventory and charging systems.
- Orders and maintains bench stock.
- Applies all modification and directions such as technical bulletin guidance.

E-12. Each brigade, with the exception of the SBCT, contains a BSB that has forward support companies and a field maintenance company. The BSB in the SBCT does not have forward support companies and is task organized as needed to provide support for battalions within the SBCT. In the other brigades, the forward support companies support the maneuver battalions and the field maintenance company supports the brigade headquarters and other non-maneuver units in the brigade such as the BSTB.

E-13. The field maintenance company contains a base support platoon that provides electronic equipment maintenance support and conducts float management of communications and electronic equipment to the forward support companies. The forward support company focuses on LRUs using combat spares from prescribed load list and shop stock. It has a service and recovery section and performs battle damage assessment and repair. The forward support company's maintenance control section uses unit level logistics system-ground to order repair parts. The forward support company commander establishes unit maintenance collection points in coordination with the maneuver battalion S-4.

BRIGADE S-6

E-14. The brigade S-6 monitors the status and sustains the brigade networks that comprise the LWN. The brigade S-6, working closely with the brigade signal company commander, BSTB staff, and the executive officer, ensures the critical network maintenance and parts needed to remain operational.

BRIGADE SIGNAL COMPANY

E-15. The brigade signal company commander coordinates network performance and maintenance issues with the brigade S-6 through the BSTB staff. The brigade signal company has operator-maintainers tasked with performing field level maintenance on organic signal assemblages. The executive officer of the signal company coordinates maintenance support for organic equipment in the signal company and maintains oversight on the status of all logistical and maintenance matters within the company.

BCT MAINTENANCE

E-16. This section is based on FM 3-90.6 and discusses maintenance procedures in the BCT. Figure E-2 is an example of BCT maintenance operations.

FIELD MAINTENANCE

E-17. Company commanders ensure that vehicle crews and equipment operators perform preventive maintenance checks and services. To provide quick turnaround of maintenance problems, each maneuver company has a field maintenance team from their supporting forward support company. This field maintenance team has contact maintenance trucks and mechanics that are trained in the company's equipment.

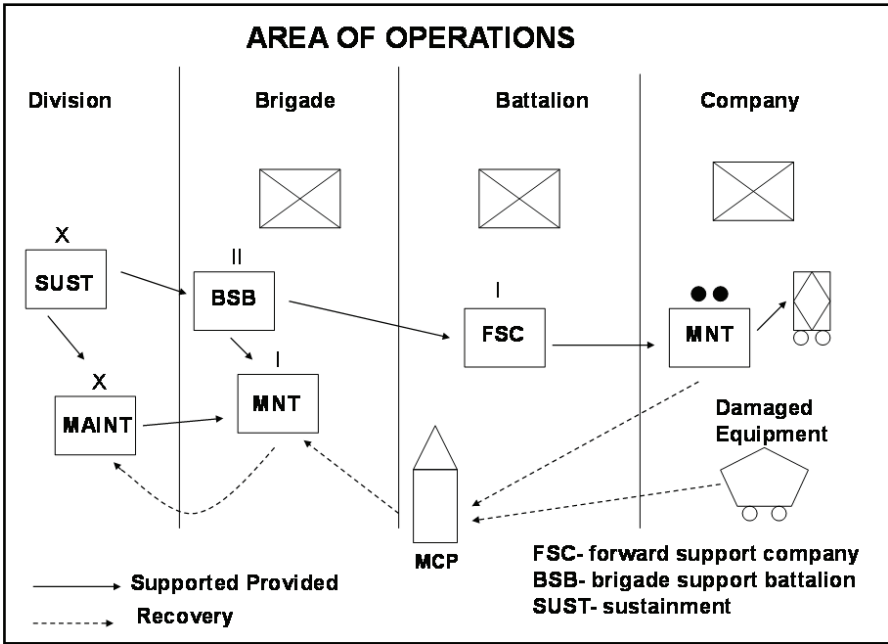

Figure E-2. BCT maintenance operations

E-18. Units not receiving support from a forward support company (for example, a BSTB) receive their maintenance support from the field maintenance company of the BSB. Located in the brigade support area, the field maintenance company provides very limited backup support to forward support companies since it exists primarily to provide support to non-maneuver units (BCT headquarters, BSB, and BSTB). It also serves as the maintenance point for low-density equipment. When required, the BSB dispatches maintenance teams to perform on-site diagnosis, make minor adjustments, and conduct repairs.

E-19. Maintenance of low density, specialized equipment (for example, BCT CPs and division signal company) usually requires maintenance by DA civilians or contractors. The BSTB S-4 must develop specific management procedures for this maintenance.

RECOVERY AND EVACUATION

E-20. Forward support companies are responsible for recovering their supported unit's damaged equipment as well as their own equipment. If the vehicle is repairable, the company recovers it to the unit maintenance collection points or main supply route based on SOP or the OPORD. The use of FBCB2 enables recovery vehicles to identify the exact location of the inoperable piece of equipment. When the decision is made to repair the equipment at the brigade support area, either recovery or evacuation is used. If the forward support company recovery assets are overextended, recovery support can be coordinated with the brigade support area to prevent excessive repair delays. Equipment that cannot be repaired at the brigade support area usually is evacuated and replaced with an operational readiness float

COMSEC MAINTENANCE

E-21. COMSEC equipment is evacuated through normal maintenance channels to the BSB or the brigade signal company, if appropriate. (Refer to TB 380-41 for information on procedures for safeguarding, accounting and supply control of COMSEC material.)

CONTROLLED EXCHANGE

E-22. Controlled exchange is the removal of serviceable parts from an item of non-mission capable equipment to install on another piece of equipment that can be rendered mission capable more quickly or easily. The BCT SOP may give battalion commanders the authority to direct control exchanges as long as controlled substitutions are conducted IAW AR 750-1, Chapters 4-9.

CONTRACTOR SUPPORT

E-23. The BCT often uses contractors and DA civilians for maintenance support. The BCT S-4 usually plans for the protection and supervision of contractors and DA civilians. System contractors support deployed forces under pre-arranged contracts. This support provides specific support to materiel systems throughout the materiel's life cycle and during peacetime and contingency operations. These systems include, but are not limited to, vehicles, weapons systems, unmanned aircraft systems, and communications equipment. System contractors usually work for their own contracting officers, not the BSB contracting officers. The Army material command usually administers its systems contractors with an in-theater logistics support element. Contractor support for CE systems is coordinated by the brigade S6 or signal company commander with the division G-6.

E-24. Protecting contractors in the operational environment is the BCT commander's responsibility. When contractors are expected to perform in potentially hostile areas, the supported military forces must assure the protection of their operations and personnel. Provisions of the Law of War do not consider contracted personnel and DOD civilians as combatants. Commanders must understand that contractors are subject to the same threat as Soldiers and must plan accordingly. Commanders must provide security to contractors that support the contractors' operations, or eliminate the use of contractor support as an option in areas where security becomes an issue. Contractor personnel cannot take an active role in hostilities, but they retain the inherent right to self defense.

CE MAINTENANCE AT THE DIVISION LEVEL

E-25. The division G-6 is responsible for monitoring the status and sustaining the division networks that comprise the LWN. The division G-6, working closely with the division signal company, division headquarters battalion staff, and the executive officer, ensures the critical network maintenance is performed and parts

are available as needed for C&E systems to remain operational. The SSIO cell is staffed to perform these functions. The deputy G-6 will ordinarily have the day-to-day responsibility of maintaining this oversight.

E-26. The division signal company staff coordinates network performance and maintenance issues with the division G-6 through the division headquarters battalion staff. The division signal company has operator/maintainers tasked with performing field level maintenance on organic signal assemblages. The executive officer of the signal company coordinates maintenance support for organic equipment in the signal company and maintains oversight on the status of all logistical and maintenance matters within the company.

CE MAINTENANCE AT THE THEATER LEVEL

E-27. NETCOM/9th SC(A) is responsible for maintenance support of all echelons above corps communications assigned by either HQDA or the CIO/G-6. This responsibility includes—

- Organization and operation of all area maintenance and supply facilities (AMSFs) supporting OCONUS commanders.
- NETCOM/9th SC(A) maintenance support teams (MSTs).
- COMSEC logistic support units.
- Module and repair activities required for direct exchange of CE material and other electronics material as assigned.

AREA MAINTENANCE AND SUPPLY FACILITY

E-28. The AMSF provides logistical support for echelons above corps non-tactical communications and information systems used in an overseas theater. There are currently two AMSFs in operation: one in Europe and one in the Pacific that provide centralized retail supply and maintenance support for all NETCOM/9th SC(A) telecommunications

Appendix E

material, and other CE material within the European and Pacific theaters of operation.

E-29. The AMSF supports the Defense Satellite Communications System, the LWN portion of the GIG, Armed Forces Radio and Television Service, Military Affiliate Radio System, and other theater unique communications or C2 systems. The AMSF may also provide support to other US military departments, DOD activities, and other US government agencies or installations.

E-30. The AMSF may be operated directly by the US Army or may be operated by a civilian contractor with US Army oversight. Soldiers, civilians and/or local national personnel may staff AMSFs.

E-31. AMSF support includes—

- Furnishing maintenance assistance support teams to provide scheduled and emergency backup maintenance and technical assistance and instruction at the CE facility or unit location that is beyond the unit's capability and authorization.
- Maintaining an authorized stockage list of CE supplies and CE repair parts.
- Maintaining approved stock record account to receive, store, and issue items on CE bills of material.
- Maintaining an approved stock of operational readiness float.
- Maintaining capability to provide a training base for specialized CE material, and to respond to emergency assistance request from supported units.
- Assisting supported units in correcting faults found during performance evaluations and inspections to improve and maintain the operational availability of CE systems and equipment.
- Operating a module and printed circuit board repair section can repair unserviceable equipment using microelectronics repair methods and automatic test equipment.
- Repairing peripheral material, such as power and environmental, when not supported by the facility engineer or other area support maintenance units.

MAINTENANCE SUPPORT TEAM

E-32. The Maintenance Support Team provides scheduled, emergency, or on-call mobile maintenance support to CE fixed facilities or other NETCOM/9th SC(A) units. Maintenance Support Teams are a functional responsibility of AMSF and other authorized command maintenance organizations.

EXPEDITIONARY SIGNAL BATTALION

E-33. The ESB has sufficient organic supply and maintenance structure to handle normal logistical requirements in garrison or when the subordinate elements are in close proximity to one another during an operation. Companies, platoons, sections, and teams that are deployed separately will ordinarily receive logistical, maintenance, and spare parts support from the supported unit. Maintenance services and repair parts for unit-unique equipment may be provided by the supported unit or may require the deployment of battalion maintenance or maintenance support unit assets. Both the battalion and companies contain CE/COMSEC maintenance sections for these purposes.

CONTRACTOR FIELD SERVICE REPRESENTATIVES

E-34. The rapid fielding of COTS based systems, in particular, the WIN-T Increment 1 suite of equipment necessitated a strong CFSR presence to establish and maintain the equipment. When originally fielded the CFSR support was division centric to provide the support in the units where they were urgently needed. As the Army has grown increasingly modular with the systems fielded to a growing number of units, it has been recognized that this system of CFSR support is too costly and manpower intensive to be maintained. As the number of trained Army specialists that are produced by institutional bases rise, the number of CFSRs required will be proportionally reduced. This will be done over time with CFSRs remaining for the near future.

Appendix E

E-35. The concept of CFSR support is moving from the division centric model to an area or regional focus, the current number of CFSRs will be responsible for support by region throughout the world rather than individual units.

E-36. Regional support centers are maintained by contract for repair of evacuated equipment as well as a repository for spare parts for affected systems within their respective regions.

SIGNAL EQUIPMENT MAINTENANCE

E-37. The signal companies at the brigade, division, corps, and theater levels have operator-maintainers performing field level maintenance on organic signal assemblages. The signal company staff coordinates network support issues and maintenance issues with the G-6/S-6 through the STB staff. The G-6/S-6 section maintains oversight responsibility for all systems within their AO.

E-38. As new communications systems are fielded and upgraded, such as the WIN-T Increment 1 suite of equipment, spare parts and critical operational floats are provided. These spare parts and equipment are maintained by the appropriate signal company and section or as specified in unit maintenance SOPs. Critical items are normally maintained at the regional support center.

COMMERCIAL-OFF-THE-SHELF EQUIPMENT

E-39. The proliferation of COTS equipment in new systems has resulted in different procedures for maintenance than required for standard Army equipment.

E-40. Common hardware system-3 (CHS-3) items as well as non-CHS-3 items under warranty that are part of fielded systems such as WIN-T Increment 1 are returned to the nearest regional support center for repair/replacement. There are three regional support centers located in CONUS, one in Germany and at other locations determined by current operations.

CE MAINTENANCE SCENARIOS

E-41. CE maintenance procedures and steps will differ based on the type of equipment involved (COTS/CHS-3 or Army standard equipment), local policies and SOPs, and METT-TC. The following two scenarios are meant to illustrate the typical flow and route of equipment and, while not all inclusive, provide a representative sample.

ARMY STANDARD EQUIPMENT

E-42. Typically, a 25U Signal Support Systems Maintainer will be notified of a problem such as a malfunctioning SINCGARS mounted in a vehicle. The 25U will troubleshoot the radio using the appropriate technical manual and diagnostic tools such as a multimeter to isolate the fault. The 25U will then repair the identified failed LRU or replace it. If the repair of the LRU is outside the scope of the 25U, the 25U will evacuate it to the supporting maintenance element for repair by the 94 series maintainer. The supporting maintenance element will evacuate the LRU, if they are unable to repair it, to the sustainment maintenance element for repair and return to the Army inventory.

COTS/CHS-3 EQUIPMENT

E-43. In the case of COTS CE equipment, the operator/maintainer, such as a 25N in a JNN, will troubleshoot the equipment and identify the fault using the appropriate TM and built-in-test equipment contained within the COTS component. After identifying the faulty component, the 25N will replace it with a spare or operational float. This will be verified by a CFSR. The faulty component is then evacuated to the supporting regional support center using the most expeditious means available, which may include mail or courier. The exact means of evacuation of the equipment will be set by local policy and SOPs.

This page intentionally left blank.

Glossary

SECTION I – ACRONYMS AND ABBREVIATIONS

ABCS	Army Battle Command System
ACERT	Army Computer Emergency Response Team
ACES	automated communications engineering software
ADCON	administrative control
A-GNOSC	Army Global Network Operations and Security Center
AHLTA	Armed Forces Health Longitudinal Technology Application
amp	ampere
AMSF	area maintenance and supply facility
AO	area of operations
AOR	area of responsibility
AR	Army regulation
ARFOR	Army forces
ASAS	All Source Analysis System
ASA	Army Signal Activity
ASCC	Army Service component command
BCT	brigade combat team

Glossary

BFT	Blue Force Tracking
BLOS	beyond line of sight
BSB	brigade support battalion
BSN	brigade subscriber node
BSTB	brigade special troops battalion
C2	command and control
CAISI	combat service support automated information systems interface
CCDR	combatant commander
CCIR	commander's critical information requirements
CE	communications and electronics
CEOI	communications-electronics operating instructions
CFSR	civilian field service representatives
CHS	common hardware system
CIO	chief information officer
CND	computer network defense
CNR	combat net radio
COA	course of action
COMCAM	combat camera
COMSEC	communications security
CONUS	continental United States

COTS	commercial off-the-shelf
CP	command post
CPN	command post node
CPOF	command post of the future
CSS	combat service support (legacy terms only)
DA	Department of the Army
DA PAM	Department of the Army pamphlet
DCS	Defense Communications System
DCGS-A	Distributed Common Ground System-Army
DHS	Department of Homeland Security
DISA	Defense Information System Agency
DISN	Defense Information Systems Network
DKET	Deployable Ku Band earth terminal
DMS	defense message system
DOD	Department of Defense
DSCS	Defense Satellite Communications System
DSD	Deployment Support Division
DVIDS	digital video imagery distribution system
EAC	echelons above corps
EHF	extremely high frequency
ELF	extremely low frequency
EMSO	electromagnetic spectrum operations

Glossary

EPLRS	Enhanced Position Location Reporting System
ESB	expeditionary signal battalion
ESTA	Enterprise Systems Technology Activity
FBCB2	Force XXI Battle Command Brigade and Below
FDMA	frequency division multiple access
FM	frequency modulated/field manual
FMI	field manual interim
FRAGO	fragmentary order
FRHN	fixed regional hub node
G-1	assistant chief of staff, personnel
G-2	assistant chief of staff, intelligence
G-3	assistant chief of staff, operations
G-4	assistant chief of staff, logistics
G-6	assistant chief of staff, network operations
G-7	assistant chief of staff, information operations
G-8	assistant chief of staff, resource management
GBS	Global Broadcast System
GCC	geographic combatant commander
GCCS-A	Global Command and Control System-Army

GIG	Global Information Grid
HCLOS	high-capacity line of sight
HF	high frequency
HQ	headquarters
HQDA	Headquarters, Department of the Army
HHC	headquarters and headquarters company
IA	information assurance
IAW	in accordance with
INSCOM	Intelligence and Security Command
IP	Internet Protocol
IR	infrared
ISYSCON	Integrated System Control
IT	information technology
J-1	personnel directorate of a joint staff
J-6	communications system directorate of a joint staff; command, control, communications, and computer systems staff section
JACS	Joint Automated Communications-Electronics Operating System
JFLCC	Joint Force Land Component Command
JNCC	joint network operations control center
JNN	joint network node
JNN-N	Joint Network Node-Network

Glossary

JOA	joint operations area
JTF	joint task force
JTF-GNO	joint task force-global network operations
kbps	kilobits per second
km	kilometer
Kw	kilowatt
LAN	local area network
LEN	large extension node
LF	low frequency
LOS	line of sight
LRM	line replaceable module
LRU	line replaceable unit
LWN	LandWarNet
Mbps	megabits per second
MC4	Medical Communications for Combat Casualty Care
MCG	mobile command group
MCO	major combat operation
MDMP	military decision making process
MEB	maneuver enhancement brigade
METT-TC	mission, enemy, terrain and weather, troops and support available, time available and civil considerations

MF	medium frequency
MOS	military occupational specialty
MRHN	mobile regional hub node
MSE	mobile subscriber equipment
NETCOM	Network Enterprise Technology Command
NETOPS	network operations
NIPRNET	Non-Secure Internet Protocol Router Network
NOC-V	network operations center-vehicle
NOSC	network operations security center
OCONUS	outside continental United States
OPCON	operational control
OPORD	operation order
PACE	primary, alternate, contingency, emergency
PIP	primary injection point
RCERT	regional computer emergency response team
RCIO	regional chief information officer
RFI	request for information
S-1	personnel staff officer
S-2	intelligence staff officer
S-3	operations staff officer

Glossary

S-4	logistics staff officer
S-6	network operations staff officer
SA	situational awareness
SATCOM	satellite communications
SBCT	Stryker brigade combat team
SC(A)	signal command (army)
SC(T)	signal command (theater)
SEN	small extension node
SHF	super high frequency
SICPS	Standardized Integrated Command Post System
SINCGARS	Single Channel Ground And Airborne Radio System
SIPRNET	SECRET Internet Protocol Router Network
SMART-T	secure, mobile, anti-jam, reliable tactical-terminal
SOF	special operations forces
SOP	standing operating procedures
SPIRIT	special purpose integrated remote intelligence terminal
STB	special troops battalion
SSIO	signal systems integration and oversight
STEP	standardized tactical entry point

STNOSC	Service theater network operations security center
TACSAT	tactical satellite
TAC CP	tactical command post
TAIS	Tactical Airspace Integration System
TDMA	time division multiple access
THN	tactical hub node
TIN	tactical installation and network
TIP	theater injection point
TM	technical manual
TMDE	test, measuring and diagnostic equipment
TNOSC	theater network operations security center
TOC	tactical operations center
TRI-TAC	Tri-Service Tactical
TROPO	Tropospheric scatter; tropospheric
TSO	telecommunications service order
TTSB	theater tactical signal brigade
UHF	ultra high frequency
UPS	uninterruptible power supply
US	United States
USARC	United States Army Reserve Command
USARSO	United States Army South
UV	ultraviolet

Glossary

VHF	very high frequency
VLF	very low frequency
VSAT	very small aperture terminal
W	watts
WAN	wide area network
WARNO	warning order
WIN-T	Warfighter Information Network-Tactical

SECTION II – TERMS

annex

(joint) A document appended to an operation order or other document to make it clearer or to give further details. (JP 1-02)

ARFOR

(Army) The Army Service component headquarters for a joint task force or a joint and multinational force. (FM 3-0)

Army Service component command

(joint) Command responsible for recommendations to the joint force commander on the allocation and employment of Army forces within a combatant command. (JP 3-31)

area of operations

(joint) An operational area defined by the joint force commander for land and naval forces. Areas of operation do not typically encompass the entire operational area of the joint force commander, but should be large enough for component commanders to accomplish their missions and protect their forces. (JP 3-0)

command and control

(Army) The exercise of authority and direction by a properly designated commander over assigned and attached forces in the accomplishment of the mission. Commanders perform command and control functions through a command and control system. (FM 6-0)

Glossary

commander's critical information requirement

(joint) Information requirements identified by the commander as being critical to facilitating timely decision-making. The two key elements are friendly force information requirements and priority intelligence requirements. (JP 3-0)

command post

(Army) A unit's or subunit's headquarters where the commander and the staff perform their activities. (FM 6-0)

communications security

(joint) The protection resulting from all measures designed to deny unauthorized persons information of value that might be derived from the possession and study of telecommunications, or to mislead unauthorized persons in their interpretation of the results of such possession and study. (JP 6-0)

computer network defense

(joint) Actions taken through computer networks to protect, monitor, analyze, detect and respond to unauthorized activity within Department of Defense information systems and computer networks. (JP 6-0)

course of action

(joint) 1. Any sequence of activities that an individual or unit may follow. 2. A possible plan open to an individual or commander that would accomplish, or is related to the accomplishment of the mission. 3. The scheme adopted to accomplish a job or mission. 4. A line of conduct in an engagement. 5. A product of the Joint Operation Planning and Execution System concept development phase and the course-of-action determination steps of the joint operation planning process. (JP 5-0)

electromagnetic spectrum

(joint) The range of frequencies of electromagnetic radiation from zero to infinity. It is divided into 26 alphabetically designated bands. (JP 1-02)

electromagnetic spectrum operations

Planning, operating, and coordinating joint use of the electromagnetic spectrum through operational, planning, and administrative procedures. The objective of electromagnetic spectrum operations is to enable electronic systems to perform their functions in the intended environment without causing or suffering unacceptable frequency interference. (FMI 6-02.70)

electronic protection

(joint) Division of electronic warfare involving actions taken to protect personnel facilities and equipment from any effects of friendly or enemy use of the electromagnetic spectrum that degrade, neutralize or destroy friendly combat capability. (JP 3-13.1)

electronic warfare

(joint) Military action involving the use of electromagnetic and directed energy to control the electromagnetic spectrum or to attack the enemy. Electronic warfare consists of three divisions: electronic attack, electronic protection, and electronic warfare support. (JP 3-13.1)

electronic warfare support

(joint) Division of electronic warfare involving actions tasked by, or under direct control of, an operational commander to search for, intercept, identify, and locate or localize sources of intentional and unintentional radiated electromagnetic energy for the purpose of immediate threat recognition, targeting, planning, and conduct of future operations. (JP 3-13.1)

Glossary

fragmentary order

(Army) A form of operation order that contains information of immediate concern to subordinates. It is an oral, digital, or written message that provides brief, specific, and timely instructions without loss of clarity. It is issued after an operation order to change or modify that order or to execute a branch or sequel to that order. (FM5-0)

identification, friend or foe

(joint) A device that emits a signal positively identifying it as a friendly. (JP 1-02)

information assurance

(joint) Measures that protect and defend information and information systems by ensuring their availability, integrity, authentication, confidentiality, and nonrepudiation. This includes providing for restoration of information systems by incorporating protection, detection, and reaction capabilities. (JP 3-13)

information dissemination management

Capability to provide a managed flow of relevant information based on the command's missions. (FM 3-13)

information system

(joint) The entire infrastructure, organization, personnel, and components that collect, process, store, transmit, display, disseminate, and act on information. (JP 1-02)

jamming

The deliberate radiation or reflection of electromagnetic energy to prevent or degrade the receipt of information by a receiver. It includes communications and noncommunications jamming. (FM 2-0)

line of sight

(joint) The unobstructed path from a Soldier/Marine, weapon, weapon sight, electronic-sending and -receiving antennas, or piece of reconnaissance equipment to another point. (FM 34-130)

multichannel

(joint) Pertaining to communications, usually full duplex, on more than one channel simultaneously. Multichannel transmission may be accomplished by either time-, frequency-, code-, and phase-division multiplexing or space diversity. (JP 1-02)

near real time

(joint) Pertaining to the timeliness of data or information which has been delayed by the time required for electronic communication and automatic data processing. This implies that there are no significant delays. (JP 1-02)

net (communications)

(joint) An organization of stations capable of direct communications on a common channel or frequency. (JP 1-02)

net control station

(joint) A communications station designated to control traffic and enforce circuit discipline within a given net. (JP 1-02)

Non-Secure Internet Protocol Router Network

Worldwide unclassified but sensitive packet switch network that uses high-speed internet protocol routers and high-capacity Defense Information Systems Network circuitry.

Glossary

operational environment

(joint) A composite of the conditions, circumstances, and influences that affect the employment of military forces and bear on the decisions of the unit commander. (JP 3-0)

request for information

(joint) 1. Any specific time-sensitive ad hoc requirement for intelligence information or products to support an ongoing crisis or operation not necessarily related to standing requirements or scheduled intelligence production. A request for information can be initiated to respond to operational requirements and will be validated in accordance with the theater command's procedures. 2. The National Security Agency/Central Security Service uses this term to state ad hoc signals intelligence requirements (JP 2-01)

sanctuary

(joint) A nation or area near or contiguous to the combat area that, by tacit agreement between the warring powers, is exempt from attack and therefore serves as a refuge for staging, logistic, or other activities of the combatant powers. (JP 1-02)

SECRET Internet Protocol Router Network

(joint) The worldwide SECRET-level packet switch network that uses high-speed internet protocol routers and high-capacity Defense Information Systems Network circuitry. (JP 6-0)

signal

(joint) 1. As applied to electronics, any transmitted electrical impulse. 2. Operationally, a type of message, the text of which consists of one or more letters, words, characters, signal flags, visual displays, or special sounds with prearranged meaning, and which is conveyed or transmitted by visual, acoustical, or electrical means. (JP 1-02)

signal operation instructions

(joint) A series of orders issued for technical control and coordination of the signal communication activities of a command. (JP 1-02)

signals intelligence

(joint) 1. A category of intelligence comprising either individually or in combination all communications intelligence, electronic intelligence, and foreign instrumentation signals intelligence, however transmitted.
2. Intelligence derived from communications, electronic, and foreign instrumentation signals. (JP 2-0)

This page intentionally left blank.

References

SOURCES USED

These are the sources quoted or paraphrased in this publication.

ARMY PUBLICATIONS

- AR 750-1. *Army Material Maintenance Policy*, 20 September 2007.
- DA PAM 600-3. *Commissioned Officer Professional Development and Career Management*, 11 December 2007.
- DA PAM 611-21. *Military Occupational Classification and Structure*, 22 January 2007.
- FM 3-0. *Operations*, 27 February 2008.
- FM 3-90.6. *The Brigade Combat Team*, 4 August 2006.
- FM 3-90.61. *The Brigade Special Troops Battalion*, 22 December 2006.
- FM 4-30.3. *Maintenance Operations and Procedures*, 28 July 2004.
- FM 5-0. *Army Planning and Orders Productions*, 20 January 2005.
- FM 6-0. *Mission Command: Command and Control of Army Forces*, 11 August 2003.
- FM 6-02.40. *Visual Information Operations*, 10 March 2009.
- FMI 3-0.1. *The Modular Force*, 28 January 2008.
- FMI 5-0.1. *The Operations Process*, 31 March 2006.
- FMI 6-02.45. *Signal Support to Theater Operations*, 05 July 2007.
- FMI 6-02.60. *Tactics, Techniques, and Procedures for the Joint Network Node-Network (JNN-N)*, 05 September 2006.
- FMI 6-02.70. *Army Electromagnetic Spectrum Management Operations*, 5 September 2006.

References

TB 380-41. *(O)Security: Procedures for Safeguarding, Accounting, and Supply Control of COMSEC Material*, 15 March 2006.

JOINT PUBLICATIONS

Clinger-Cohen Act of 1996, Title 40. 10 February 1996.

DOD Directive 8100.1. *Management of the Department of Defense Information Enterprise*, 27 February 2002.

DOCUMENTS NEEDED

These documents must be available to the intended user of this publication.

DA Form 2028. Recommended Changes to Publications and Blank Forms.

DA Forms are available on the APD web site (www.apd.army.mil).

Index

A

- ACERT, 4-8, 4-9, 4-24
- A-GNOSC, 4-7, 4-8, 4-9
- All Source Analysis System, B-3, B-4, B-5
- area of
 - operations, 1-4, 1-5, 1-9, 1-10, 1-22, 1-23, 1-24, 1-27, 1-42, 1-43, 3-4, 3-10, 5-9, 6-12, A-1, A-4, A-8, A-9, E-14
- Armed Forces Health Longitudinal Technology Application, 6-6, 6-7, 6-8
- Army Battle Command System, 1-5, 1-10, 1-23, 1-42, 6-3, 6-16, 6-17, B-1, B-2, B-3, B-4, B-5, B-6, B-8
- Army command, 4-41
- Army forces, 1-9, 1-22, 1-32, 1-33, 1-37, 1-44, 3-9
- ASCC, 4-1, 4-4, 4-7, 4-17, 4-18, 4-19, 4-22, 4-24, 4-25, 4-40, 4-49
- assistant chief of staff, command, control, communication s, and computer operations, 1-21
- assistant chief of staff, information operations, 1-22, 1-42
- assistant chief of staff, intelligence, 1-22, 1-42, 6-9, A-9
- assistant chief of staff, network operations, 1-7, 1-9, 1-10, 1-11, 1-17, 1-20, 1-21, 1-22, 1-23, 1-24, 1-25, 1-27, 1-28, 1-29, 1-30, 1-31, 1-32, 1-33, 1-38, 1-41, 1-42, 1-43, 1-45, 2-1, 2-2, 2-3, 2-4, 2-5, 2-6, 2-7, 2-8, 2-9, 2-10, 2-11, 2-14, 2-15, 2-17, 2-18, 3-5, 3-6, 3-9, 3-10, 3-11, 5-1, 5-5, 6-9, 6-14, 6-15, A-3, A-4, A-6, A-9, B-7, E-3, E-10, E-11, E-14
- assistant chief of staff, operations, 1-17, 1-21, 1-22, 1-23, 1-28, 1-41, 1-42, 1-43, 3-5, 3-10, 4-45, A-9
- assistant chief of staff, personnel, 1-23, 1-43
- automated communication s engineering software, A-6, A-8

Index

B

BCT, 4-19, 4-31,
4-34, 4-48, 4-
50

beyond line of
sight, 1-4, 1-
12, 1-14, 1-15,
1-35

BLOS, 4-38

Blue Force
Tracking, 1-3,
6-2, B-5

brigade combat
team, 1-1, 1-4,
1-7, 1-11, 1-12,
1-13, 1-14, 1-
31, 3-4, 3-9, 3-
10, 3-12, 6-17,
E-7, E-8, E-9,
E-10

brigade special
troops
battalion, 1-11

brigade support
battalion, E-4,
E-5, E-6, E-8,
E-9, E-10

C

CIO, 4-4, 4-5, 4-
6, 4-7, 4-19, 4-
25

combat camera,
4-43, 4-44, 4-
45, 4-46, 4-47

combat net
radio, 1-4, 6-2,
A-4, B-7

combat service
support, 1-18,
6-3, 6-4

combat service
support
automated
information
systems
interface, 6-3,
6-4

combatant
command, 4-6,
4-18, 4-19, 4-
22, 4-40, 4-50

combatant
commander, 4-
5

command and
control, 4-43

command post
node, 1-3, 1-4,
5-1, 5-4, 5-8,
5-10

command post of
the future, 6-
17, B-3

command,
control,
communication
s, and
computer
operations
directorates of a
joint staff, 1-11,
1-22, 1-45, 1-
46, 3-5, 3-10,
4-20, 4-21

commander's
critical
information
requirements,
1-3

commercial-off-
the-shelf, 1-29,
6-17, A-6, B-1,
C-1, E-1, E-2,
E-13, E-14, E-
15

communications
security, 1-5, 1-
9, 1-32, 1-44,
1-45, 2-2, 2-3,
2-19, 4-21, E-
4, E-5, E-9, E-
11, E-13

communications-
electronics, 4-
45

communications-
electronics
operating
instructions, 2-
19, A-6, A-8,
A-9

computer network
defense, 1-3,
1-5, 1-11, 1-31,
1-43, 3-7

COMSEC, 1-5, 4-
11, 4-15, 4-16,
4-17, 4-18, 4-
19, 4-22

contemporary
operational
environment,
4-10

course of action,
 1-2, 2-4, 2-5,
 2-6, 2-7, 2-8,
 2-9, 2-10, 2-11
 CPN, 4-37, 4-38

D

Defense Imagery
 Management
 Operations
 Center, 4-43

Defense
 Information
 System
 Agency, 5-5

Defense
 Information
 Systems
 Network, 1-36,
 5-6

Defense
 Switched
 Network, 4-45

Department of
 Defense, 4-47

Department of
 Defense
 directive, 4-47

DHS, 4-2, 4-3

digital visual
 imagery
 distribution
 system, 6-8

DISA, 4-16, 4-24

DISN, 4-24, 4-40

DNS, 4-9, 4-49

DOIM, 4-31

DRSN, 4-40

E

electromagnetic
 spectrum
 operations, 1-
 3, 1-5, 1-7, 1-9,
 1-11, 1-21, 1-
 22, 1-28, 1-41,
 1-42, 4-21, A-
 1, A-2

Enhanced
 Position
 Location
 Reporting
 System, 1-14,
 1-17, 2-19, 5-9,
 6-2, B-5, B-7,
 C-2

ESB, 4-2, 4-28, 4-
 33, 4-34, 4-35,
 4-36, 4-38, 4-
 39, 4-41

ESTA, 4-7

expeditionary
 signal
 battalion, 5-5,
 5-10, E-13

F

fixed regional hub
 node, 3-8, 3-9,
 3-12, 5-4, 5-5,
 5-7

Force XXI Battle
 Command
 Brigade and
 Below, 5-9, 6-

2, B-5, B-6, C-
 2, E-9

fragmentary
 order, 1-17, 1-
 21, 3-5, 3-10

frequency division
 multiple
 access, 1-35,
 1-36, 5-3, 5-4,
 5-6, 5-7

G

GIG, 4-1, 4-3, 4-
 4, 4-6, 4-7, 4-
 11, 4-12, 4-21

Global Broadcast
 System, 1-27,
 6-9, 6-10, 6-11,
 6-12, 6-13, 6-
 14, 6-15

Global Command
 and Control
 System-Army,
 6-17

Global
 Information
 Grid, 1-24, 1-
 27, 1-28, 1-29,
 1-30, 1-35, 1-
 43, , 3-1, 3-2,
 3-3, 3-6, 3-8,
 3-9, 3-12, 5-1,
 5-2, 5-4, 5-5,
 B-8, E-12

H

HQDA, 4-4, 4-7,
 4-9, 4-26, 4-31

Index

I

IA, 4-7, 4-9, 4-15,
4-20, 4-24
information
assurance, 1-3,
1-5, 1-10, 1-11,
1-22, 1-27, 1-
29, 1-31, 1-42,
1-430, 3-6, 3-7,
4-21, 5-6, C-2
information
superiority, 4-1
Integrated
System
Control, 5-12,
5-13, A-6, A-8,
B-7
intelligence staff
officer, 1-5, 1-
10, 2-5, 6-9, A-
9
ITSB, 4-33, 4-34,
4-41

J

JNCC, 4-19, 4-24
JNN, 4-34, 4-37
JNTC-S, 4-35
Joint Automated
Communications
Electronics
Operating
Instructions
System, A-6,
A-8
Joint Automated
Communications-
Electronics

Operating

System, A-6
Joint Chiefs of
Staff, 4-43, 4-
47
Joint Force, 4-3,
4-33
joint network,
4-3, 4-34
Joint Force Land
Component
Command, 1-
37, 1-42, 1-44,
3-10
joint network
node, 1-14, 1-
15, 1-29, 1-35,
2-8, 5-1, 5-2,
5-3, 5-4, 5-8,
5-9, 5-10, 6-5
Joint Network
Node-Network,
5-1, 5-3
joint operations
area, 1-20
joint task force, 1-
22, 1-23, 1-28,
1-32, 1-33, 1-
37, 1-42, 1-44,
1-45, 1-46, 3-5,
3-10, 4-43, 4-
47
Joint Visual
Information
Service
Distribution
Activity, 4-43

L

LandWarNet, 1-
24, 4-1, 4-2, 4-
3, 4-4, 4-6, 4-7,
4-8, 4-9, 4-10,
4-11, 4-12, 4-
13, 4-18, 4-19,
4-20, 4-21, 4-
24, 4-25, 4-30,
4-31, 4-48
large extension
node, 5-12, 5-
13, 5-14
line of sight, 1-14,
1-15, 1-35
line-of-sight, 2-23,
2-24, 2-25, 5-2,
5-8, 5-9, 5-11,
5-12, 5-13, 5-
14, 6-4, A-6, A-
9, C-1
local area
network, 1-2,
1-5, 1-10, 1-14,
1-30, 5-3, 6-4,
6-15, B-7
logistics staff
officer, 6-4, E-
3, E-5, E-6, E-
9, E-10

M

maneuver
enhancement
brigade, 1-12
maneuver
enhancement
brigade, 1-15

Medical
 Communications for Combat
 Casualty Care,
 6-5, 6-6, 6-7

messaging
 systems
 DMS, 4-15, 4-40

military decision
 making
 process, 1-2, 1-3, 2-1, 2-18, 3-5

military
 occupational
 specialty, 1-6, 6-6, C-1, E-2

mobile subscriber
 equipment, 2-24, 5-1, 5-2, 5-3, 5-5, 5-9, 5-11, 5-12, 5-13, 5-14

modular army, 4-1, 4-3, 4-33, 4-34, 4-38, 4-48

MSE, 4-33

N

NATO, 4-25, 4-31

NETCOM, 4-1, 4-4, 4-5, 4-6, 4-7, 4-8, 4-9, 4-12, 4-13, 4-21, 4-22, 4-26, 4-27, 4-28, 4-31, 4-32, 4-39

NETOPS, 4-6, 4-7, 4-8, 4-11, 4-19, 4-25, 4-48, 4-49, 4-50

Network
 Enterprise
 Technology
 Command, 4-47

network
 operations, 1-5, 1-9, 1-17, 1-23, 1-24, 1-29, 1-30, 1-33, 1-35, 1-42, 1-43, 3-2, 3-4, 3-6, 3-8, 3-9, 3-10, 3-11, 3-12, 4-20, 5-5, C-2

Network
 Operations and
 Security
 Center, 1-9, 1-17, 1-21, 1-30, 1-31, 1-32, 1-43, 1-44

network
 operations
 directorate of a
 joint staff, 1-42, 1-45

network
 operations staff
 officer, 1-3, 1-4, 1-5, 1-6, 1-7, 1-9, 1-10, 1-11, 1-12, 1-17, 1-18, 1-46, 2-1, 2-2, 2-3, 2-4,

2-5, 2-6, 2-7, 2-8, 2-9, 2-10, 2-11, 2-14, 2-15, 2-16, 2-17, 2-18, 3-5, 3-6, 3-9, 3-10, 3-11, 5-1, 5-9, 6-9, 6-15, A-3, A-4, A-9, B-7, E-3, E-4, E-5, E-6, E-7, E-14

network
 operations staff
 officer, 1-3

network support,
 4-2, 4-3, 4-18, 4-28, 4-39

networks, 4-2, 4-3, 4-4, 4-7, 4-8, 4-16
 strategic, 4-19
 tactical, 4-2, 4-9, 4-19, 4-49

NIPRNET, 4-40

Non-Secure
 Internet
 Protocol
 Router
 Network, 1-4, 1-29, 1-36, 5-2, 5-6, 6-3, 6-7

O

Office of the
 Secretary of
 Defense, 4-41, 4-43

Index

operation order,
1-27, 2-1, 2-9,
2-16, 2-17, 2-
18, 2-19, 3-5,
D-1, D-2, E-9

operations
full spectrum
operations,
4-35
information
operations,
4-20

operations staff
officer, 1-4, 1-
5, 1-6, 1-7, 1-
10, 1-11, 1-17,
2-3, 2-7, 2-19,
3-10, 4-45, 5-5,
A-9

P

personnel
directorates of a
joint staff, 1-45

primary injection
point, 6-11

primary,
alternate,
contingency,
emergency, 2-
8

R

RCIO, 4-27

reachback, 4-2,
4-3, 4-6

request for
information, 2-
3

S

satellite
communication
s, 1-3, 1-15, 1-
36, 2-18, 2-19,
3-12, 5-6, 5-10,
6-2, 6-3, B-7,
C-1

Secret Internet
Protocol
Router
Network, 1-4,
1-29, 1-36, 5-2,
5-6, 6-7, 6-14,
A-7, A-9

secure, mobile,
anti-jam,
reliable
tactical-
terminal, 1-15,
1-35, 5-2, 5-10

Service Theater
Network
Operations and
Security
Center, 1-11,
1-22, 1-31, 1-
32, 1-42, 1-43,
1-44

signal command
(Army), 4-47

Single Channel
Ground and
Airborne Radio
System, 1-17,
1-36, 2-9, 5-9,
6-2, A-2, B-5,
B-7, C-2, E-15

SIPRNET, 4-40

situational
awareness, 4-
19

small extension
node, 5-13

special troops
battalion, 1-24,
1-33, 1-37, 1-
43, 1-46, E-3

Standardized
Integrated
Command Post
System, 6-16,
6-17

standing
operating
procedures, 1-
3, 1-5, 1-9, 2-3,
2-16, 2-17, B-
6, E-3, E-9

STEP, 4-8

super high
frequency, 2-
22, 5-14

T

tactical command
post, 1-14, 1-
18, 1-19, 1-20,
1-24, 1-29, 1-
33, 1-35, 1-36,
1-37, 1-38, 2-9,
2-15, 5-14

tactical hub node,
3-8, 3-9, 5-4,
5-5, 5-6, 5-7,
5-8

- tactical
 - operations
 - center, 2-8, 2-15, 2-17, 5-9
- tactical satellite, 2-2, 2-9, 2-19, 5-12, 5-14, 6-2
- telecommunications service order, 3-10
- teleport facilities, 4-8, 4-16
- theater of
 - operations, 4-5, 4-24, 4-28, 4-30
- time division
 - multiple
 - access, 1-30, 1-35, 1-36, 5-3, 5-4, 5-6, 5-7, 5-8
- TIN, 4-39, 4-40, 4-41, 4-42
- TNCC, 4-19
- TNOSC, 4-8, 4-9, 4-20, 4-22, 4-24, 4-48, 4-49, 4-50, 4-51, 4-52
 - TIC, 4-48, 4-49, 4-50, 4-51, 4-52
 - TLT, 4-50, 4-51, 4-52
 - TNT, 4-48, 4-51, 4-52
 - TNT, 4-48
- TOC, 4-8
- Tri-Service
 - Tactical, 5-1, 5-5, 5-9, 5-14
- TROPO, 4-33, 4-38
- tropospheric, 5-2
- tropospheric scatter, 5-12, 5-14, C-2
- TTSB, 4-28, 4-29, 4-32, 4-34, 4-41
- U**
- ultra high
 - frequency, 2-22, 5-13, 5-14, 6-12
- uninterruptible
 - power supply, 2-28, 5-11
- United States, 4-44, 4-47
- V**
- very small
 - aperture
 - terminal, 1-27, 5-10, 6-3, 6-4
- VI
 - documentation, 4-41
- visual information*, 4-41, 4-43, 4-45
- visual information
 - documentation, 4-41
- VTC, 4-24, 4-40
- W**
- warning order, 2-1, 2-2, 2-4, 2-6, 2-9, 2-15, 2-18
- wide area
 - network, 1-10, 1-42, 5-13, 6-15
- WIN-T, 4-35
- wireless network
 - extension, 1-12, 1-14, 2-4, 2-5, 2-11, 2-14, 2-15, 2-19, 2-23

This page intentionally left blank.

FM 6-02.43
17 March 2009

By order of the Secretary of the Army:

GEORGE W. CASEY, JR.
General, United States Army
Chief of Staff

Official:

A handwritten signature in black ink that reads "Joyce E. Morrow". The signature is written in a cursive, flowing style.

JOYCE E. MORROW
Administrative Assistant to the
Secretary of the Army
0906205

DISTRIBUTION:

Active Army, Army National Guard, and US Army Reserve: To be distributed in accordance with the initial distribution number 115998 required for FM 6-02.43

PIN: 085426-000